

MAXIMATOR®

Maximum Pressure.

FAMiBA
www.famiba.sk



High Pressure Technology • Testing Equipment
Hydraulics • Pneumatics

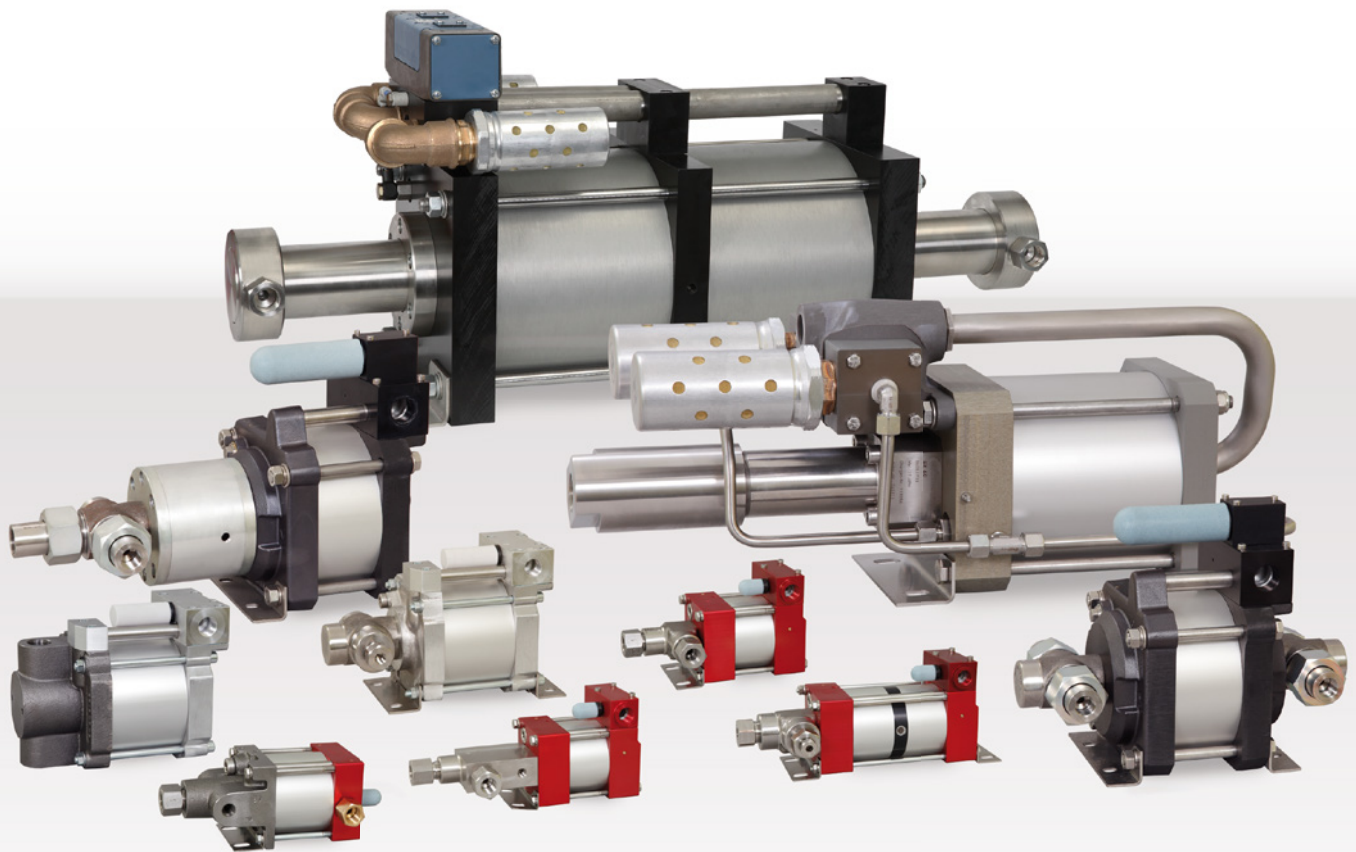

» Air driven high pressure pumps
up to 7,000 bar (101,000 psi).

Content

Content:	Page:
MAXIMATOR worldwide, the Maximator-Concept	2 – 3
General Information, Pump selection	4 – 5
Fields of application of hydraulic pumps, Pump range overview	6 – 7
Pumps for oil or oil-water emulsion up to 1,000 bar (14,500 psi)	
– MO Series	8 – 9
– S Series	10 – 11
Pumps for water, oil or oil-water emulsion up to 7,000 bar (101,000 psi)	
– M Series	12 – 15
– S...SS Series	16
– G Series	17 – 19
Pumps for the chemical and offshore industries and special fluids up to 3,000 bar (43,500 psi)	
– MSF Series	20
– GSF Series	21
– GPD Series	22 – 23
– GX Serie	24
– DPD Series	25
Pump selection, pump capacity tables	26 – 31
Media compatibily guide	32 – 33
Accessories	34 – 35
Additional products, Hydraulics and pneumatics	36 – 37
Additional products, High-pressure technology and testing equipment	38 – 39

At your side, everywhere

As an internationally leading company specialising in high-pressure technology, MAXIMATOR develops high-performance air driven liquid pumps for a variety of uses and applications. For decades we have supported well-known companies in the automotive and supply industry, as well as the chemical, plastics, oil and gas industries.

In addition to air driven liquid pumps, we also produce air amplifiers, gas boosters and high-pressure technology such as valves, fittings, pressure switches and other components. We also offer extensive services in the field of high-pressure testing and production technology. Our devices satisfy the requirements of the pressure equipment, machinery and ATEX directives and, on request, NACE specifications.



We follow strict quality guidelines certified according to ISO 9001. In order to ensure the continuous further development of our products, we maintain a close cooperation with our customers as well as with material and component suppliers.

With four technical offices in Germany and qualified partner companies worldwide, we can offer optimal customer service. A total of over 350 qualified, highly motivated employees work at our production centre in Nordhausen.

Maximator technology

High-pressure pumps – the Maximator concept

Maximator high-pressure pumps can be used for many technical applications in engineering and industry – even in explosion-proof areas. They generate pressure using oil, water or special fluids in a reliable, cost-effective way. The pumps are based on the design principle of an oscillating pressure intensifier, so that pumping continues when the pressure drops. The pumps are driven with compressed air at 1 to 10 bar.

Easy handling

1. Initial operation

The pump is prepared for operation manually:

- Connect supply lines (compressed air, suction and pressure lines)
- Set air drive pressure
- Open compressed air supply slowly so that the high-pressure pump starts up

2. Build up pressure

The pump technology executes all the steps for pressure build-up automatically:

- Automatic cycling of 4/2-way valve (spool cycling valve) by means of air pulses from the pilot valve (2/2-way valve)
- Suction of medium
- Optimum cycling conditions thanks to large cross-sections

3. Achieve and hold pressure

The pump controls the processes of reaching and holding pressure.

- Pump automatically stops operating when the operating pressure is reached due to equilibrium of forces
- Pressure is held
- Pressure holding phase with no energy consumption or heat generation
- Pump restarted automatically if operating pressure drops

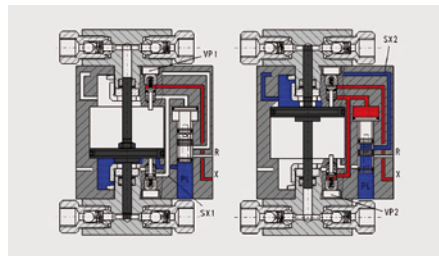

The Maximator pumps in detail

The advantages of Maximator pumps:

- Pressure regulation via manual pressure regulator or pneumatically actuated valve
- Operation with compressed air allows use in explosion-proof areas
- Pump automatically stops operating upon reaching pre-selected final pressure
- Suitable for most liquids and liquified gases
- No power consumption during long pressure holding periods
- No heat generation during pressure holding period
- Easy installation and trouble-free handling of pumps
- Low maintenance thanks to reliable, easy-to-install devices

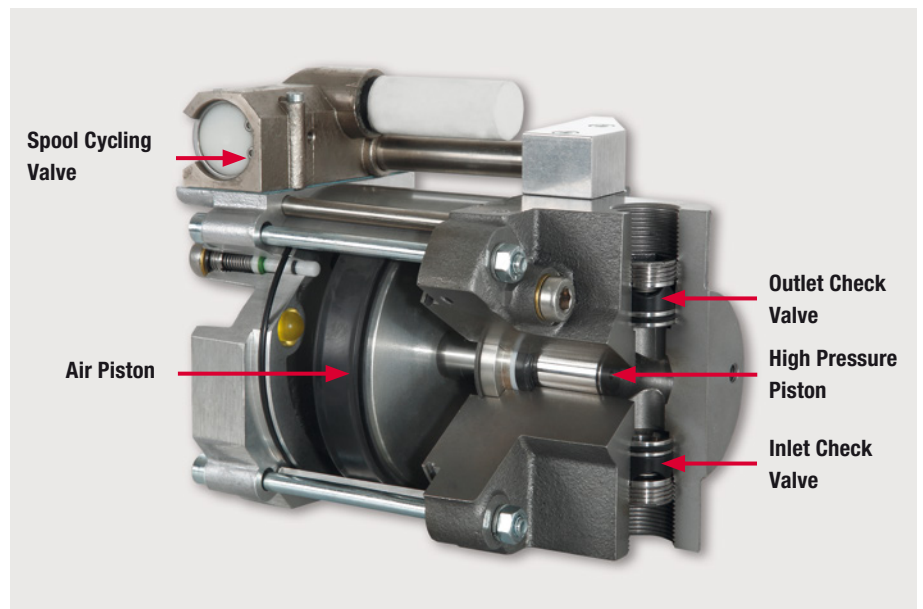

General information

The series and its functions

Maximator pumps offer the right solution for every application. They are suitable for different or stepped flow rates as well as for different maximum allowable operating pressures. The models are available in six different sizes: M, S, G, GX, GPD and DPD. The pressure ratio of the pump (surface ratio between the air drive piston and the high-pressure piston) can be seen from the type designation of the pump in question. The G35, for example, has a pressure ratio (i) of 1:40 and achieves a maximum operating pressure (pB) of 240 bar at an air drive pressure (pL) of 6 bar. The following model variants are available depending on the series:



One air drive section

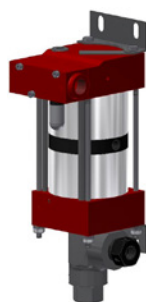

Two air drive sections



Three air drive sections



Single-acting

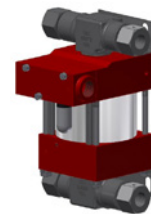

Double-acting

Maximator pumps with two or three air drive sections reach the same final pressure as a Maximator pump with one air drive section with $\frac{1}{2}$ or $\frac{1}{3}$ of the air drive. Double-acting pumps increase the pump capacity by around 50% in comparison to single-acting pumps and reduce the pulsation equally.

Selecting the right pump

1. Data for pump design

The following parameters are required for designing and selecting pumps:

- Required operating pressure
- Desired pump capacity at operating pressure
- Available air drive pressure
- Medium
- Temperature of the medium
- Ambient Temperature

Depending on the application, you may require additional data. Feel free to contact us – we are happy to assist in the designing process.

2. Required operating pressure and pump capacity

Specifications of pump operating pressures are essentially based on an air drive pressure of $P_L = 10$ bar (145 psi). The operating pressure (P_B) can be determined by multiplying the pressure ratio of the pump (i) by the available air drive pressure (P_L) $P_B = i \times P_L$.

Specifications of pump capacity at the respective outlet pressure can be found in the pump capacity tables following the information about our pump series featured in this catalogue (page 26-33).

3. Medium

The pump model should be selected to match the medium to be pumped, as it is the properties of this medium which determine the requirements for the sealing materials and the wetted parts. Maximator pumps are suitable for a large variety of media. Standard designs are available for oil and water and for many special media.

Medium		
Oil	Oil / Water	Special Media
MO-Series	M-Series	MSF-Series
S-Series	S...SS-Series	GSF-Series
	G-Series	GX-Series
	GPD-Series	
	DPD-Series	

If your medium is not included in the overview (page 32/33), we will check suitable combinations for you.

4. Dimensions and weight

Some applications require special pump dimensions and weights. Please refer to the tables and option lists for our pump series for more information about this as well as on the availability of the „side inlet“ option.

General information for pump operation

Pump installation

Maximator pumps can always be operated in any position, although the horizontal position is effective in preserving the seals. For fault-free operation, the devices should be lined with fittings and tubings which are suitable for the desired pressure range. The connection sizes should never be reduced.

The connections of Maximator pumps are available as BSPP-threads and can be designed optionally as NPT threads. Both threads are suitable for pressures up to 1,050 bar (15,000 psi). For higher pressure applications, from 1,050 bar upwards, we recommend the use of Maximator high-pressure fittings.

We offer high-pressure connections in sizes 1/4", 3/8", 9/16", 3/4" and 1" for pressures up to 7,000 bar. Depending on the pressure range, one distinguishes here between „medium pressure“ (1,550 bar [22,500 psi]), „high pressure“ (4,500 bar [65,000 psi]) and „ultra-high pressure“ (7,000 bar [101,000 psi]).

Please consult the Maximator Valves, Fittings and Tubing catalog, chapter „Tools and Installation“ for more detailed information about the Maximator high-pressure connections.

Before starting operation

The connection for the compressed air drive is located on the spool cycling valve housing. Series S...D, G and GSF models have a second connection (marked by „X“) for direct pilot valve air for switching the pump on and off via solenoid valves with small nominal size.

Pilot-valve air must be connected upstream of a pressure controller for pumps using direct pilot air. If the direct pilot-valve air is not connected, the pump will not function.

Before starting operation, a compressed air filter with a water separator should be mounted in the air drive line in front of the pump. We offer the technical accessories to match each series under „air control unit C1, C2 or C3“.

As a rule, Maximator pumps do not require a compressed air oiler, as they are treated with special grease during assembly. An upstream connection of an oiler is recommendable if the pump is to be operated with very dry air and the duty cycle exceeds 50%.

After operating the pump with oiled compressed air, it is advisable to retain this variant for subsequent applications. Should you change to unoiled compressed air, the pump should be retreated with special grease.

Drive air

In order to ensure optimal durability for the seal and guide elements, the drive air should meet the specifications of quality grades from 3 to 4 (solids/ water / oil):

Air quality in accordance with ISO 8573-1	
Specification	Value
max. compressed air purity of oil (class 4):	5 mg/m ³
max. number of particles at 0,1 - 0,5 µm size (class 3):	90.000 pce.
max. number of particles at 1,0 - 5,0 µm size (class 3):	1.000 pce.
max. solids, particle concentration:	5 mg/m ³
max. pressure dew point at moisture (Klasse 4):	+3 °C

Recommended hydraulic oils

Proper operation and efficiency of the pumps is mainly depending on the quality of the used hydraulic liquid. We recommend hydraulic oils with a viscosity between 46 – 68 cst (DIN 51524 T2; DIN 51519). To prevent damage to both the inlet and outlet check valves and the high pressure seal, a filter with a mesh width below 100 µm must be fitted to the suction pipe.

Temperatures

The standard operating temperatures of Maximator pumps range between -20°C and +80°C. Pumps with sealing version -VE for water operation can be used at temperatures up to +60°C, with short-term operation possible up to +80°C.

Emission protection

Air-driven pumps can cause such emissions as noise or air contamination from the fluid. Persons located in the vicinity of running pumps should always wear protective glasses and, if necessary, ear protection.

Type designation

The type designations of Maximator pumps specify, as far as possible, the pressure ratio of the pump and contain information about the sealing version as well as additional options. Instructions regarding the order code can be found in the information on our individual pump series.

Fields of application of hydraulic pumps

Pumps for oil up to 1,000 bar (14,500 psi)

- **Lifting and clamping:** Hydraulic systems for lifting and shifting loads, lifting tables, aircraft jacking
- **Hydraulic applications:** Clamping devices, punching and pin presses, chucks, actuation of cylinders
- **Presses:** cold isostatic presses, filter presses, hydraulic presses, pressure generation for presses and press overload protection
- **Tooling and Tightening:** actuating cropping, crimping, cable shears and pipe bending tools, roller tensioning and torque wrenches
- **Testing:** tensile test machines and pressure testing
- **Lubrication systems**

» MO and S Series

Their compact, light construction as well as their numerous pressure ratios make the MO and S series predestined for a large number of applications in oil hydraulics. The pumps are available in both single-acting and double-acting design.



Type MO



Type S

Pumps for water and oil up to 7,000 bar (101,000 psi)

- **Hydrostatic tests:** Valves, tanks, pressure vessels, pressure switches, hoses, pipes and tubing, pressure gauges, cylinders, transducers, well casings, BOPs, gas cylinders and components from aerospace technology
- **Burst and Cycle fatigue testing** for parts mentioned above
- **Calibration:** Pressure gauges and transducers
- **Water jet cutting and cleaning**
- **Leak testing**
- **Emergency shutdown systems** for oil and gas wells
- **Pressurization** of accumulators for testing numerous components
- **Operation and Control** of well service and well head equipment

» M, S...SS and G Series

Thanks to their stainless-steel wetted parts, M, S...SS and G pumps are optimally suited for use in water hydraulics. They are available as single-acting and double-acting pumps as well as in one-, two- (M and G) or three-stage (M only) design.

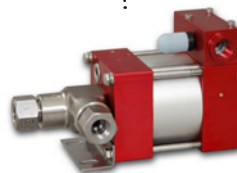

Type M

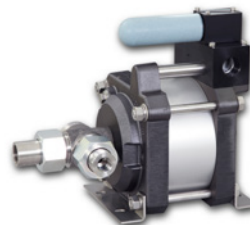

Type G

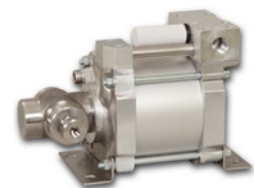

Type S...SS

Pumps for the chemical and offshore industries up to 3,000 bar (43,500 psi)

- **Injection of inhibitors** such as methanol and glycol in wells
- **Injection of coolants**
- **Aviation and Automotive Testing:**
brake fluid, skydrol, transmission fluid and power steering fluid
- **Pipeline testing**
- **Charging hydraulic accumulators**
- **Actuation of subsea valves**

» MSF, GSF, GX and GPD Series

With their configuration of distance piece, leakage borehole and PTFE seal, the MSF and GSF pump models meet the specific requirements of the chemical industry.

The GX and GPD pumps are distinguished by high pump capacities and have proved very effective for the rough operational conditions of the offshore industry. With their robust construction, their stainless steel wetted parts, and their high corrosion resistance, they can withstand extreme stress.

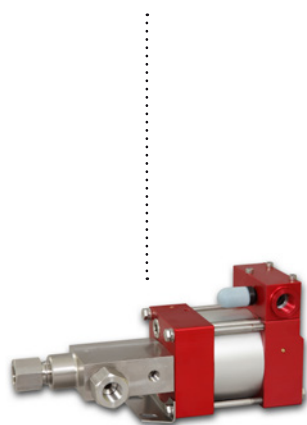

Type MSF

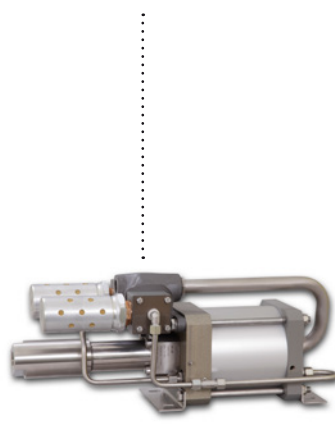

Type GX

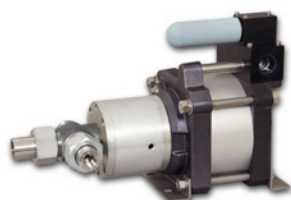

Type GSF

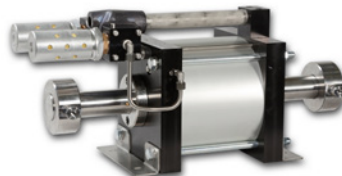

Type GPD

Pumps for special applications

- **Water jet cutting** (for intermittent operation)
- **Pressure generation for Mandrel Extraction Machines**

» DPD Series

DPD pumps are large, double-acting pumps with high pump capacities working at high operating pressures of up to 2,100 bar (30,450 psi).



Type DPD

Oil operation – MO series up to 1,000 bar

Maximator pumps of the MO series are available in single- or double-acting design with one air drive piston. They are suitable for use in zone 1, category 2G/2D IIC TX explosion-proof areas (temperature class depending on medium temperature).

MO-Pumps

- » Single-acting
- » With one air drive piston
- » Operating pressures of up to 1,000 bar (14,500 psi)

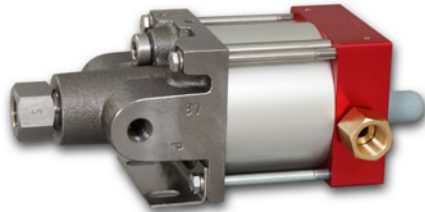

The light and robust MO pumps are available with a very large variety of pressure ratios. They are ideal for use as portable pump units.

- Material: Pump heads made of cast iron, pistons made of tool steel and seal made of polyurethane
- Standard design with bottom inlet
- For air drive pressures of 1 to 10 bar (14.5 bis 145 psi)

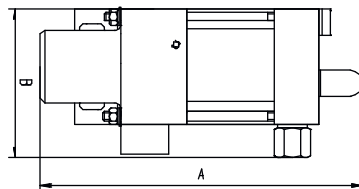
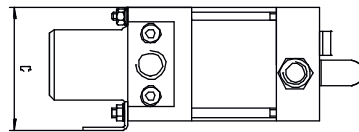

Options for MO and MO-D pumps

- Side inlet for single-acting, single air drive section pumps
Order code: M037 – S
- Direct pilot valve air modification for single-acting, one-stage pumps (for switching on/off via an external solenoid valve) -
Order code: M022(D) to M0189(D): M037(D) – DIR

Type	Pressure ratio*	Displ. Volume **		Outlet pressure ***		Flow capacity l/min ****	Connections			Dimensions in mm			Weight kg
		cm ³	cu.inch	bar	psi		Air Drive L	Inlet A	Outlet B	A	B	C	
M04	1:4	30.5	1.86	40	580	14.81	3/8 BSPP	3/4 BSPP	1/2 BSPP	190	102	80	2.5
M08	1:9	14.7	0.90	90	1305	7.07	3/8 BSPP	3/4 BSPP	1/2 BSPP	190	102	80	2.5
M012	1:14	9.4	0.57	140	2030	4.55	3/8 BSPP	3/4 BSPP	1/2 BSPP	190	102	80	2.5
M022	1:29	4.6	0.28	290	4205	2.22	3/8 BSPP	3/8 BSPP	1/4 BSPP	228	102	80	3.0
M037	1:47	2.8	0.17	470	6815	1.36	3/8 BSPP	3/8 BSPP	1/4 BSPP	228	102	80	3.0
M072	1:88	1.5	0.09	880	12760	0.72	3/8 BSPP	3/8 BSPP	1/4 BSPP	228	102	80	3.0
M0111	1:133	1.0	0.06	1000	14500	0.48	3/8 BSPP	3/8 BSPP	1/4 BSPP	228	102	80	3.0
M0189	1:225	0.6	0.04	1000	14500	0.28	3/8 BSPP	3/8 BSPP	1/4 BSPP	228	102	80	3.0

* Ratio – driving surface air drive piston / driven surface high pressure piston (calculated)

** Displacement volume per double stroke (calculated).

*** Static outlet pressure (calculated and maximum allowed)

**** Approximate flow at an air drive of 6 bar / 87 psi and an outlet pressure of 0 bar/psi.

(14,500 psi)

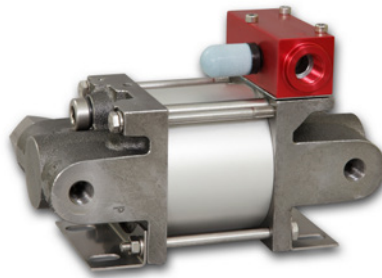

MO...D-Pumps

- » Double-acting
- » With one air drive piston
- » Operating pressures of up to 1,000 bar (14,500 psi)

The MO...D pumps run with lower pulsation than the single-acting MO pumps and achieve an approx. 50% higher pump capacity.

- Standard pumps with side inlet only

- Special connections, e.g. with NPT thread
Order code: M037(D) – NPT
- Air control unit for MO(D) pumps, consisting of a filter/pressure regulator combination, control pressure gauge and shut-off valve
Order code: M037(D) with C1

Other options available on request.

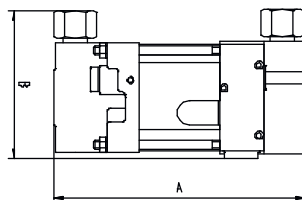
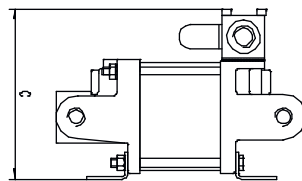

Type	Pressure ratio*	Displ. Volume **		Outlet pressure ***		Flow capacity l/min ****	Connections			Dimensions in mm			Weight kg
		cm ³	cu.inch	bar	psi		Air Drive L	Inlet A	Outlet B	A	B	C	
M022D	1:28	9.2	0.56	280	4060	3.91	3/8 BSPP	3/8 BSPP	1/4 BSPP	186	108	118	4.5
M037D	1:46	5.6	0.34	460	6670	2.35	3/8 BSPP	3/8 BSPP	1/4 BSPP	186	108	118	4.5
M072D	1:86	3.0	0.18	860	12470	1.24	3/8 BSPP	3/8 BSPP	1/4 BSPP	186	108	118	4.5
M0111D	1:130	2.0	0.12	1000	14500	0.82	3/8 BSPP	3/8 BSPP	1/4 BSPP	186	108	118	4.5
M0189D	1:220	1.2	0.07	1000	14500	0.49	3/8 BSPP	3/8 BSPP	1/4 BSPP	186	108	118	4.5

Oil operation – S series up to 1,000 bar

Maximator pumps of the S series are available in single- or double-acting design with one air drive piston. They are suitable for use in zone 1, category 2G/2D IIB TX explosion-proof areas (temperature class depending on medium temperature).

S-Pumps

- » Single-acting
- » With one air drive piston
- » Operating pressures of up to 1,000 bar (14,500 psi)



The light and compact S pumps can be used with units for steady operation and in mobile applications. They already start at an air drive pressure of 1 bar (14.5 psi) and can be used for precision work.

- Material: Pump heads made of cast iron, pistons made of tool steel and seal made of polyurethane
- Only available with side inlet
- Maximum air drive pressure: 10 bar (145 psi)

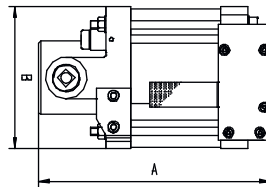
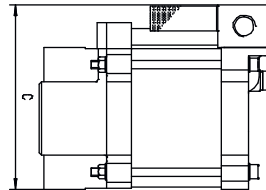

Options for S pumps

- Special connections, e.g. with NPT thread
- Order code: S35(D) - NPT**

Type	Pressure ratio*	Displ. Volume **		Outlet pressure ***		Flow capacity l/min ****	Connections			Dimensions in mm			Weight kg
		cm ³	cu.inch	bar	psi		Air Drive L	Inlet A	Outlet B	A	B	C	
S15	1:17	28.3	1.73	170	2465	9.38	1/2 BSPP	3/4 BSPP	3/4 BSPP	221	135	175.5	9.1
S25	1:25	19.6	1.20	250	3625	6.72	1/2 BSPP	3/4 BSPP	3/4 BSPP	221	135	175.5	9.1
S35	1:39	12.6	0.77	390	5655	4.31	1/2 BSPP	3/4 BSPP	3/4 BSPP	221	135	175.5	9.1
S60	1:61	8.0	0.49	610	8845	2.75	1/2 BSPP	1/2 BSPP	3/8 BSPP	221	135	175.5	9.1
S100	1:108	4.5	0.27	1000	14500	1.55	1/2 BSPP	1/2 BSPP	3/8 BSPP	221	135	175.5	9.1
S150	1:156	3.1	0.19	1000	14500	1.08	1/2 BSPP	1/2 BSPP	3/8 BSPP	221	135	175.5	9.1

* Ratio – driving surface air drive piston / driven surface high pressure piston (calculated)

** Displacement volume per double stroke (calculated).

*** Static outlet pressure (calculated and maximum allowed)

**** Approximate flow at an air drive of 6 bar / 87 psi and an outlet pressure of 0 bar/psi.

(14,500 psi)

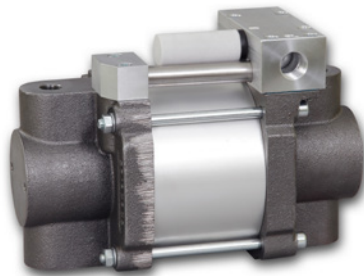

S...D-Pumps

- » Double-acting
- » With one air drive piston
- » Operating pressures of up to 1,000 bar (14,500 psi)

The S...D pumps run with lower pulsation than the single-acting S pumps and achieve an approx. 50% higher pump capacity.

- Connection for direct pilot valve air for switching the pump on and off via solenoid valves with small nominal size

- Air control unit for S pumps, consisting of a filter/pressure regulator combination, control pressure gauge and shut-off valve

Order code: S35(D) with C1.5

Other options available on request.

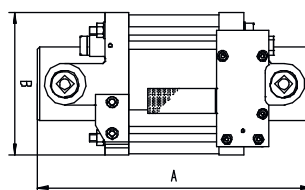
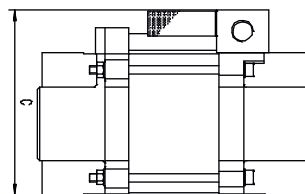

Type	Pressure ratio*	Displ. Volume **		Outlet pressure ***		Flow capacity l/min ****	Connections			Dimensions in mm			Weight kg
		cm ³	cu.inch	bar	psi		Air Drive L	Inlet A	Outlet B	A	B	C	
S15D	1:16	57.0	3.48	160	2320	17.56	1/2 BSPP	3/4 BSPP	3/4 BSPP	260	135	175.5	14.5
S25D	1:24	39.0	2.39	240	3480	12.00	1/2 BSPP	3/4 BSPP	3/4 BSPP	260	135	175.5	14.5
S35D	1:38	25.2	1.54	380	5510	7.58	1/2 BSPP	3/4 BSPP	3/4 BSPP	260	135	175.5	14.5
S60D	1:60	16.0	0.98	600	8700	4.80	1/2 BSPP	1/2 BSPP	3/8 BSPP	260	135	175.5	14.5
S100D	1:107	9.0	0.55	1000	14500	2.68	1/2 BSPP	1/2 BSPP	3/8 BSPP	260	135	175.5	14.5
S150D	1:155	6.2	0.38	1000	14500	1.85	1/2 BSPP	1/2 BSPP	3/8 BSPP	260	135	175.5	14.5

Water or oil operation – M series up to 4,000 bar

Maximator pumps of the M series are available in single- or double-acting design with one, two or three air drive pistons. They are suitable for use in zone 1, category 2G/2D IIC TX explosion-proof areas (temperature class depending on medium temperature).

M-Pumps

- » Single-acting
- » With one air drive piston
- » For operating pressures up to 2,200 bar (31,900 psi)

M pumps in single-acting design are distinguished by their light, compact construction.

- Material: M4, M8 and M12: Pump heads made of aluminium, pistons made of stainless steel; M22 to M189: stainless steel pump heads and pistons
- With UHMWPE seal and FKM O-ring
- Standard models with bottom inlet, side inlet optionally available

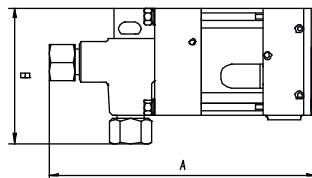
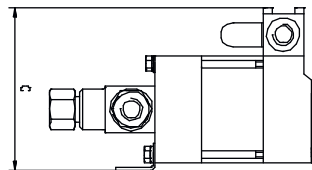
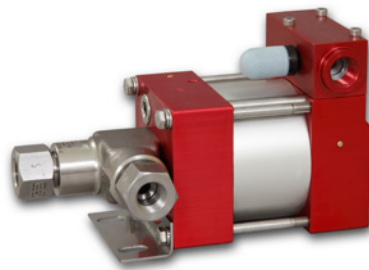

Options for M pumps

- Seal version for optimised water operation: (not available for M ...-2 /M...-3 and M...-01HL versions) up to 2,000 bar (29,000 psi)
Order code: M37 - (L)VE / M37D - VE
- Seal version for oil operation (standard)
Order code: M37 - (L)
- Seal versions for special media - **Order code: See media compatibility guide**
- Side inlet for single-acting M pumps - **Order code: M37(L) - S/M37(L)VE - S**
- Direct pilot valve air modification for single-acting, single air drive section types pumps M4 to M189: (for switching pump on/off via an external solenoid valve with small nominal size)
Order code: M37 - DIR

Type	Pressure ratio*	Displ. Volume **		Outlet pressure ***		Flow capacity l/min ****	Connections			Dimensions in mm			Weight kg
		cm ³	cu.inch	bar	psi		Air Drive L	Inlet A	Outlet B	A	B	C	
M4	1:4	30.5	1.86	40	580	14.81	3/8 BSPP	1 BSPP	1/2 BSPP	216	120	112	3.0
M8	1:9	14.7	0.90	90	1305	7.07	3/8 BSPP	3/4 BSPP	1/2 BSPP	209	120	112	3.0
M12	1:14	9.4	0.57	140	2030	4.55	3/8 BSPP	3/4 BSPP	1/2 BSPP	209	120	112	3.0
M22	1:28	4.6	0.28	280	4060	2.22	3/8 BSPP	3/8 BSPP	3/8 BSPP	195	104	112	2.8
M37	1:46	2.8	0.17	460	6670	1.36	3/8 BSPP	3/8 BSPP	3/8 BSPP	195	104	112	2.8
M72	1:86	1.5	0.09	860	12470	0.72	3/8 BSPP	3/8 BSPP	3/8 BSPP	195	104	112	2.8
M111	1:130	1.0	0.06	1300	18850	0.48	3/8 BSPP	3/8 BSPP	3/8 BSPP ①	195	104	112	2.8
M189	1:220	0.6	0.04	2200	31900	0.28	3/8 BSPP	3/8 BSPP	3/8 BSPP ①	195	104	112	2.8

* Ratio – driving surface air drive piston / driven surface high pressure piston (calculated)

** Displacement volume per double stroke (calculated).

*** Static outlet pressure (calculated and maximum allowed)

**** Approximate flow at an air drive of 6 bar / 87 psi and an outlet pressure of 0 bar/psi.

① High pressure pumps with outlet connections type BSPP or NPT are suitable for outlet pressures of up to 1,050 bar (15,000 psi). For higher outlet pressures, the pumps must be ordered with high pressure connections according to the required pressure range.

(58,000 psi)

- Spring return and hand lever attachment modification only available for M22 to M189 single acting, single air drive head types)

Order code: M37 - 01HL

- Special connections, e.g. with NPT thread

Order code: M37 - NPT

- Air control unit for M(D) pumps, consisting of a filter/pressure regulator combination, control pressure gauge and shut-off valve

Order code: M37(D) with C1

- Air control unit as above with additional safety valve in the drive air line for limiting the operating pressure on the high-pressure side **Order code: M37(D) with C1/SVAir (Please indicate the operating pressure to be set.)**

Other options available on request.

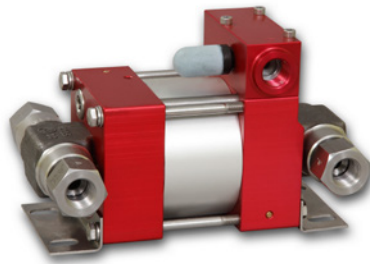

M...D-Pumps

- » Double-acting
- » With one air drive piston
- » Operating pressures of up to 2,200 bar (31,900 psi)

M...D pumps provide approx. 50% more pump capacity than M pumps with lower pulsation.

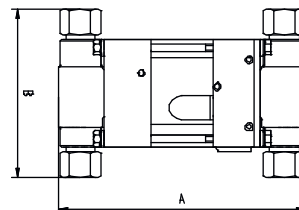
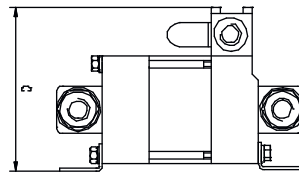

Type	Pressure ratio*	Displ. Volume **		Outlet pressure ***		Flow capacity l/min ****	Connections			Dimensions in mm			Weight kg
		cm ³	cu.inch	bar	psi		Air Drive L	Inlet A	Outlet B	A	B	C	
M4D	1:3	61	3.7	30	440	25	3/8 BSPP	1 BSPP	1/2 BSPP	314	119	112	4,7
M8D	1:8	29.4	1.8	80	1160	12	3/8 BSPP	3/4 BSPP	1/2 BSPP	300	119	112	3,7
M12D	1:13	18.3	1.15	130	1890	7.8	3/8 BSPP	3/4 BSPP	1/2 BSPP	300	119	112	3,7
M22D	1:28	9.2	0.56	280	4060	3.91	3/8 BSPP	3/8 BSPP	3/8 BSPP	184	124	112	3.7
M37D	1:46	5.6	0.34	460	6670	2.35	3/8 BSPP	3/8 BSPP	3/8 BSPP	184	124	112	3.7
M72D	1:86	3.0	0.18	860	12470	1.24	3/8 BSPP	3/8 BSPP	3/8 BSPP	184	124	112	3.7
M111D	1:130	2.0	0.12	1300	18850	0.82	3/8 BSPP	3/8 BSPP	3/8 BSPP ①	184	124	112	3.7
M189D	1:220	1.2	0.07	2200	31900	0.49	3/8 BSPP	3/8 BSPP	3/8 BSPP ①	184	124	112	3.7

Water or oil operation – M series up to 4,000 bar

Maximator pumps of the M series are available in single- or double-acting design with one, two or three air drive pistons. They are suitable for use in zone 1, category 2G/2D IIC TX explosion-proof areas (temperature class depending on medium temperature).

M...-2-Pumps

- » **Single-acting**
- » **With two air drive pistons**
- » **Operating pressures of up to 4,000 bar (58,000 psi)**

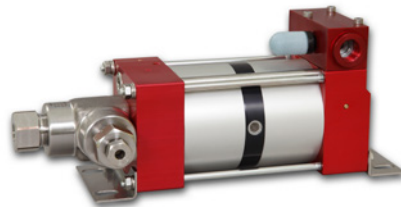

M...-2 pumps in single-acting design with two air drive pistons achieve twice the operating pressure of single-acting, single air drive section M pumps with the same drive pressure.

- Standard models with polyurethane seal
- Standard models with bottom inlet, side inlet optionally available

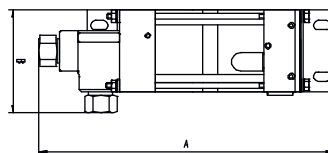
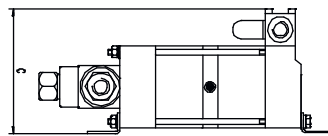

Options for M-Pumps

- Seal version for oil operation (standard)
Order code: M189-(2)(3)(L)
- Seal versions for special media
Order code: See media compatibility guide
- Side inlet for single-acting M pumps
Order code: M189-(2)(3)(L) - S
- Special connections, e.g. with BSPP or NPT thread
- Air control unit for M pumps, consisting of a filter/pressure regulator

Type	Pressure ratio*	Displ. Volume **		Outlet pressure ***		Flow capacity l/min ****	Connections			Dimensions in mm			Weight kg
		cm ³	cu.inch	bar	psi		Air Drive L	Inlet A	Outlet B	A	B	C	
M111-2	1:261	1.0	0.06	2500	36250	0.35	3/8 BSPP	1/4 BSPP	9/16-18 UNF	255	100	112	3.9
M189-2	1:440	0.6	0.04	4000	58000	0.21	3/8 BSPP	1/4 BSPP	9/16-18 UNF	255	100	112	3.9

* Ratio – driving surface air drive piston / driven surface high pressure piston (calculated)

** Displacement volume per double stroke (calculated).

*** Static outlet pressure (calculated and maximum allowed)

**** Approximate flow at an air drive of 6 bar / 87 psi and an outlet pressure of 0 bar/psi.

(58,000 psi)



M...-3-Pumps

- » Single-acting
- » With three air drive pistons
- » Operating pressures of up to 4,000 bar (58,000 psi)

M...-3 pumps in single-acting design with three air drive pistons achieve three times the operating pressure of single-acting, single air drive section M pumps with the same drive pressure.

- Standard models with polyurethane seal
- Standard models with bottom inlet, side inlet optionally available

combination, control pressure gauge and shut-off valve - **Order code: M189-(2)(3) with C1**

- Air control unit as above with additional safety valve in the drive air line for limiting the operating pressure on the high-pressure side - **Order code: M189-(2)(3) with C1/SVAir (Please indicate the operating pressure to be set.)**

Other options available on request.

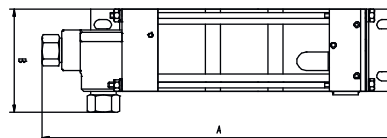
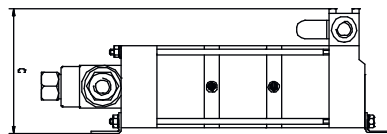

Type	Pressure ratio*	Displ. Volume **		Outlet pressure ***		Flow capacity l/min ****	Connections			Dimensions in mm			Weight kg
		cm ³	cu.inch	bar	psi		Air Drive L	Inlet A	Outlet B	A	B	C	
M111-3	1:391	1.0	0.06	2500	36250	0.24	3/8 BSPP	1/4 BSPP	9/16-18 UNF	316	100	112	4.6
M189-3	1:660	0.6	0.04	4000	58000	0.14	3/8 BSPP	1/4 BSPP	9/16-18 UNF	316	100	112	4.6

Water or oil operation – S...SS and G series up to

Maximator pumps of the S...-SS series are available in single-acting design with one air drive piston. They are suitable for use in zone 1, category 2G/2D IIB TX explosion-proof areas (temperature class depending on medium temperature).

S...-SS-Pumps

- » Single-acting
- » With one air drive piston
- » Operating pressures of up to 3,700 bar (53,660 psi)

The light, compact S...-SS pumps are ideally suited both for units for steady operation and for mobile applications. They already start at an air drive pressure of only 1 bar (14.5 psi) and are ideal for applications which require fast reaction times.

- Components in contact with medium made of stainless steel
- Stainless steel pump heads and pistons and UHMWPE seal
- Only available with side inlet
- Maximum air drive pressure: 10 bar (145 psi)

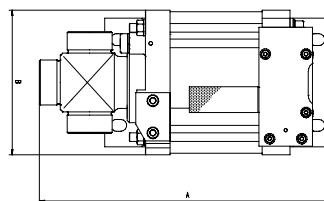
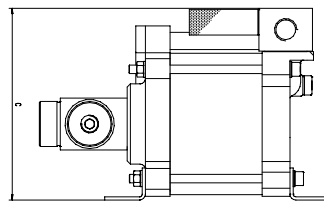
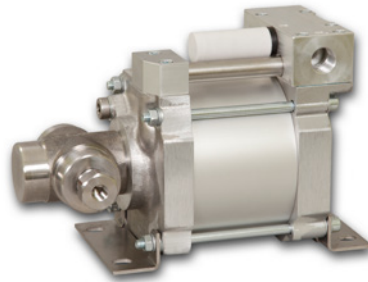

Options for S...-SS-Pumps

- Special connections, e.g. with NPT thread
Order code: S160SS - NPT
- Air control unit for M pumps, consisting of a filter/pressure regulator combination, control pressure gauge and shut-off valve - **Order code: S160SS with C1.5**

Other options available on request.

Type	Pressure ratio*	Displ. Volume **		Outlet pressure ***		Flow capacity l/min ****	Connections			Dimensions in mm			Weight kg
		cm ³	cu.inch	bar	psi		Air Drive L	Inlet A	Outlet B	A	B	C	
S40-SS	1:39	12.0	0.76	390	5650	4.0	1/2 BSPP	3/8 BSPP	3/8 BSPP	272	135	179	7
S80-SS	1:80	6.0	0.37	800	11600	2.0	1/2 BSPP	3/8 BSPP	3/8 BSPP	272	135	179	7
S160-SS	1:160	3.0	0.18	1630	23635	1.1	1/2 BSPP	1/4 BSPP	9/16-18 UNF (4H)	272	135	179	7
S200-SS	1:200	2.4	0.15	1930	28000	0.9	1/2 BSPP	1/4 BSPP	9/16-18 UNF (4H)	258	135	179	7
S250-SS	1:244	2.0	0.12	2400	34800	0.6	1/2 BSPP	1/4 BSPP	9/16-18 UNF (4H)	258	135	179	7
S350-SS	1:370	1.0	0.08	3700	53660	0.45	1/2 BSPP	1/4 BSPP	9/16-18 UNF (4H)	258	135	179	7

* Ratio – driving surface air drive piston / driven surface high pressure piston (calculated)

** Displacement volume per double stroke (calculated).

*** Static outlet pressure (calculated and maximum allowed)

**** Approximate flow at an air drive of 6 bar / 87 psi and an outlet pressure of 0 bar/psi.

ⓘ High pressure pumps with outlet connections type BSPP or NPT are suitable for outlet pressures of up to 1,050 bar (15,000 psi). For higher outlet pressures, the pumps must be ordered with high pressure connections according to the required pressure range.

7,000 bar (101,000 psi)

Maximator pumps of the G series are available in single- or double-acting design with one or two air drive pistons. They are suitable for use in zone 1, category 2G/2D IIC TX explosion-proof areas (temperature class depending on medium temperature).

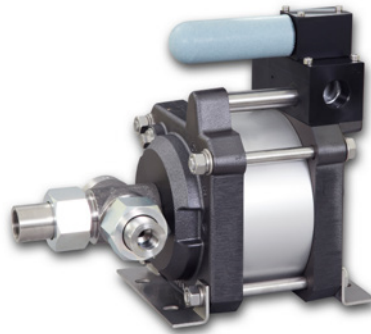

G-Pumps

- » Single-acting
- » With one air drive piston
- » Operating pressures of up to 4,500 bar (65,250 psi)

- Material: Stainless-steel pump heads and pistons
- Polyurethane seal; recommended for water operation: UHMWPE seal
- Standard models with bottom inlet, side inlet available on request
- G500(S) is only available with side inlet
- Maximum air drive pressure 10 bar (145 psi)
- Connection for direct pilot valve air for switching the pump on and off via solenoid valves with small nominal size

Options for G-Pumps

Note: Please refer to the information on models G...D and G...-2 on the following pages for the different options for G pumps.

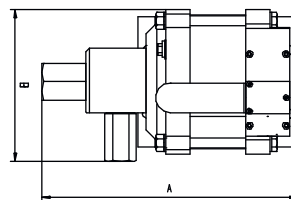
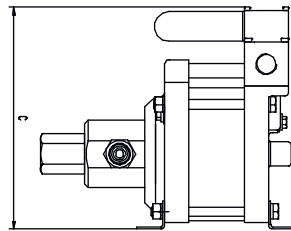

Type	Pressure ratio*	Displ. Volume **		Outlet pressure ***		Flow capacity l/min ****	Connections			Dimensions in mm			Weight kg
		cm ³	cu.inch	bar	psi		Air Drive L	Inlet A	Outlet B	A	B	C	
G10	1:11	90.0	5.49	110	1595	18.53	3/4 BSPP	1 BSPP	3/4 BSPP	311	190.5	272	16.0
G15	1:16	62.0	3.78	160	2320	12.86	3/4 BSPP	1 BSPP	3/4 BSPP	311	190.5	272	16.0
G25	1:28	35.3	2.15	280	4260	7.24	3/4 BSPP	3/4 BSPP	3/4 BSPP	296	181	272	14.5
G35	1:40	24.5	1.49	400	6800	5.02	3/4 BSPP	3/4 BSPP	3/4 BSPP	296	181	272	14.5
G60	1:63	15.4	0.94	630	9135	3.21	3/4 BSPP	3/4 BSPP	1/2 BSPP	321	184.5	272	13.5
G100	1:113	8.8	0.54	1050	15225	1.81	3/4 BSPP	3/4 BSPP	1/2 BSPP	321	184.5	272	13.5
G150	1:151	6.6	0.40	1450	21025	1.36	3/4 BSPP	3/4 BSPP	1/2 BSPP ^①	321	184.5	272	13.5
G250	1:265	3.8	0.23	2650	38425	0.77	3/4 BSPP	1/2 BSPP	9/16-18 UNF	300	193.5	272	13.5
G300	1:314	3.2	0.20	3140	45530	0.65	3/4 BSPP	1/2 BSPP	9/16-18 UNF	300	193.5	272	13.5
G400	1:398	2.5	0.15	3980	58000	0.51	3/4 BSPP	1/2 BSPP	9/16-18 UNF	300	193.5	272	13.5
G500S	1:519	1.9	0.12	4500	65250	0.39	3/4 BSPP	1/4 BSPP	9/16-18 UNF	362	181	272	13.5

Water or oil operation – G series up to 7,000 bar

Maximator pumps of the G series are available in single- or double-acting design with one or two air drive pistons. They are suitable for use in zone 1, category 2G/2D IIC TX explosion-proof areas (temperature class depending on medium temperature).

G...D-Pumps

- » Double-acting
- » With one air drive piston
- » Operating pressures of up to 4,500 bar (65,250 psi)

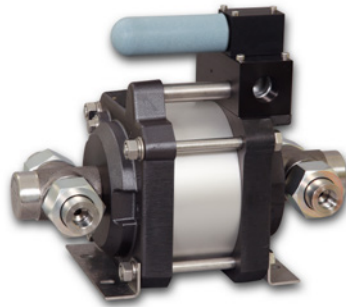

G...D pumps in double-acting design with one air drive piston provide approx. 50% more pump capacity than single-acting G pumps with lower pulsation.

- Standard models with UHMWPE seal with FKM O-ring
- Standard models with bottom inlet, side inlet available on request
- G60D(S) - G150D(S) with side inlet only
- Maximum air drive pressure 10 bar (145 psi)
- Connection for direct pilot valve air for switching the pump on and off via solenoid valves with small nominal size

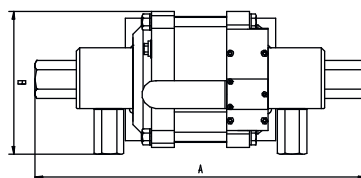
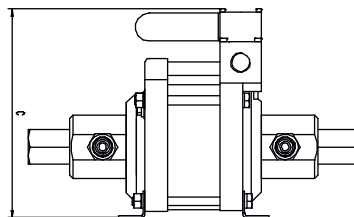

Options for G pumps

- Seal version for optimised water operation up to 4,000 bar (58,000 psi):
Order code: G35 - (L)VE / G35D - VE
(not available for G500S and G500-2S)
- Seal version for oil operation
Order code: G35 - (L)
- Seal versions for special media
Order code: See media compatibility guide
- Side inlet (G500(S), G500-2(S) and G60D(S) to G150(D)S available with side inlet only) - **Order code: G35(L) - S / G35(L)VE - S**
Other options available on request.

Type	Pressure ratio*	Displ. Volume **		Outlet pressure ***		Flow capacity /min ****	Connections			Dimensions in mm			Weight kg
		cm ³	cu.inch	bar	psi		Air Drive L	Inlet A	Outlet B	A	B	C	
G10D	1:10	180.0	10.98	100	1450	28.85	3/4 BSPP	1 BSPP	3/4 BSPP	442	190.5	272	22.0
G15D	1:15	124.0	7.56	150	2175	19.84	3/4 BSPP	1 BSPP	3/4 BSPP	442	190.5	272	22.0
G25D	1:27	70.6	4.31	270	3915	11.34	3/4 BSPP	3/4 BSPP	3/4 BSPP	412	181	272	19.0
G35D	1:40	49.0	2.99	400	6800	7.74	3/4 BSPP	3/4 BSPP	3/4 BSPP	412	181	272	19.0
G60DS	1:63	31.4	1.92	630	9135	5.04	3/4 BSPP	3/4 BSPP	1/2 BSPP	344	184.5	272	17.0
G100DS	1:113	17.6	1.07	1050	15225	2.78	3/4 BSPP	3/4 BSPP	1/2 BSPP	344	184.5	272	17.0
G150DS	1:151	7.6	0.46	1450	21025	2.10	3/4 BSPP	3/4 BSPP ①	1/2 BSPP	344	184.5	272	17.0

* Ratio – driving surface air drive piston / driven surface high pressure piston (calculated)

** Displacement volume per double stroke (calculated).

*** Static outlet pressure (calculated and maximum allowed)

**** Approximate flow at an air drive of 6 bar / 87 psi and an outlet pressure of 0 bar/psi.

① High pressure pumps with outlet connections type BSPP or NPT are suitable for outlet pressures of up to 1,050 bar (15,000 psi). For higher outlet pressures, the pumps must be ordered with high pressure connections according to the required pressure range.

(101,000 psi)

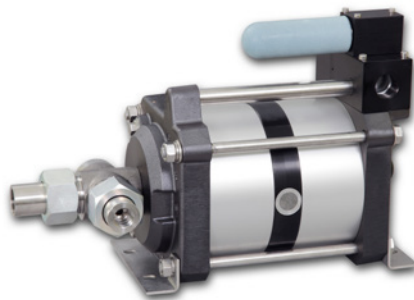

G...-2-Pumps

- » Single-acting
- » With two air drive pistons
- » Operating pressures up to 7,000 bar (101,000 psi)

G...-2 pumps in single-acting design with two air drive pistons provide twice the operating pressure of single-acting G pumps with the same air drive pressure.

- Standard models with UHMWPE seal with FKM O-ring
- Standard models with bottom inlet, side inlet available on request
- G500-2(S) available with side inlet only
- Maximum air drive pressure 10 bar (145 psi)

- Special connections, e.g. with NPT thread
Order code: G35(L) - NPT

- Air control unit for G pumps, consisting of a filter/pressure regulator combination, control pressure gauge and shut-off valve - **Order code: G35(L) with C2**

- Air control unit as above with additional safety valve in the air drive line for limiting the operating pressure on the high-pressure side - **Order code: G35(L) with C2/SVAir (Please indicate the operating pressure to be set.)**
Also applies to the G models shown on the preceding page

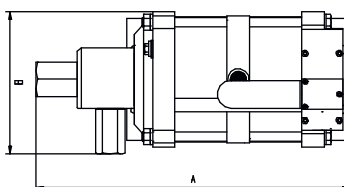
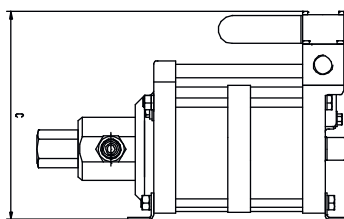

Type	Pressure ratio*	Displ. Volume **		Outlet pressure ***		Flow capacity l/min ****	Connections			Dimensions in mm			Weight kg
		cm ³	cu.inch	bar	psi		Air Drive L	Inlet A	Outlet B	A	B	C	
G10-2	1:22	90.0	5.49	220	3190	15.89	3/4 BSPP	1 BSPP	3/4 BSPP	411	211	272	20.5
G15-2	1:32	62.0	3.78	320	4640	11.02	3/4 BSPP	1 BSPP	3/4 BSPP	411	211	272	20.5
G25-2	1:56	35.3	2.15	560	8120	6.19	3/4 BSPP	3/4 BSPP	3/4 BSPP	396	211	272	19.0
G35-2	1:80	24.5	1.49	800	11600	4.30	3/4 BSPP	3/4 BSPP	3/4 BSPP	396	211	272	19.0
G60-2	1:126	15.4	0.94	1260	18270	2.76	3/4 BSPP	3/4 BSPP	1/2 BSPP ①	421	211	272	18.0
G100-2	1:226	8.8	0.54	2100	30450	1.55	3/4 BSPP	1/2 BSPP	9/16-18 UNF	400	211	272	18.0
G150-2	1:300	6.6	0.40	2900	42050	1.16	3/4 BSPP	1/2 BSPP	9/16-18 UNF	400	211	272	18.0
G250-2	1:530	3.8	0.23	4500	65250	0.66	3/4 BSPP	1/4 BSPP	9/16-18 UNF	483	211	272	22.0
G300-2	1:628	3.2	0.20	4500	65250	0.56	3/4 BSPP	1/4 BSPP	9/16-18 UNF	483	211	272	22.0
G400-2	1:796	2.5	0.15	5500	79750	0.44	3/4 BSPP	1/4 BSPP	9/16-18 UNF	483	211	272	22.0
G500-2	1:1038	1.4	0.09	7000	101500	0.34	3/4 BSPP	1/4 BSPP	5/8-18 UNF	462	211	272	22.0

Chemical and offshore industries – MSF and GSF

MSF-Pumps

- » **Single-acting**
- » **With one air drive piston**

Thanks to their robust construction, MSF pumps are especially suited for applications in the chemical industry.

- Distance piece and leakage borehole
- Operating pressures of up to 1,000 bar (14,500 psi)
- MSF pump heads and pistons made of stainless steel
- PTFE seal material
- Standard design with bottom inlet
- Maximum air drive pressure: 10 bar (145 psi).

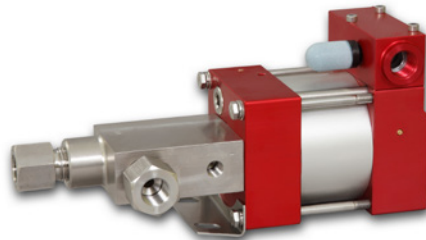
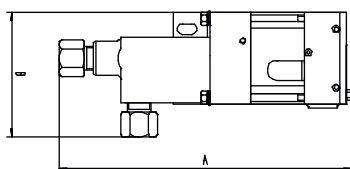
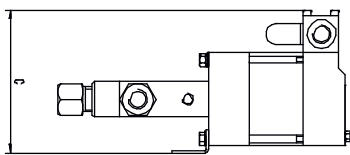

All high-pressure pumps from the MSF series are suitable for use in zone 1, category 2G/2D IIC TX explosion-proof areas (temperature class depending on medium temperature).

Options for MSF pumps

- Seal versions for special media
Order code: See media compatibility guide
- Side inlet:
Order code: MSF37-S
- Special connections, e.g. with NPT thread
Order code: MSF37 - NPT
- Air control unit for MSF pumps, consisting of a filter/pressure regulator combination, control pressure gauge and shut-off valve
Order code: MSF37 with C1
- Air control unit as above with additional safety valve in the air drive line for limiting the operating pressure on the high-pressure side - **Order code: MSF37 with C1/SVAir (Please indicate the operating pressure to be set.)**

Type	Pressure ratio*	Displ. Volume **		Outlet pressure ***		Flow capacity l/min ****	Connections			Dimensions in mm			Weight kg
		cm ³	cu.inch	bar	psi		Air Drive L	Inlet A	Outlet B	A	B	C	
MSF4	1:4	30.5	1,86	40	580	14.81	3/8 BSPP	1 BSPP	1/2 BSPP	248	112	120	6.7
MSF8	1:9	14.7	0,90	90	1305	7.07	3/8 BSPP	3/4 BSPP	1/2 BSPP	241	112	120	6.7
MSF12	1:14	9.4	0,57	140	2030	4.55	3/8 BSPP	3/4 BSPP	1/2 BSPP	241	112	120	6.7
MSF22	1:28	4.6	0,28	280	4060	2.22	3/8 BSPP	3/8 BSPP	3/8 BSPP	247	112	108	3.5
MSF37	1:46	2.8	0,17	460	6670	1.36	3/8 BSPP	3/8 BSPP	3/8 BSPP	247	112	108	3.5
MSF72	1:86	1.5	0,09	860	12470	0.48	3/8 BSPP	3/8 BSPP	3/8 BSPP	247	112	108	3.5
MSF111	1:130	1.0	0,06	1000	14500	0.28	3/8 BSPP	3/8 BSPP	3/8 BSPP	247	112	108	3.5

* Ratio – driving surface air drive piston / driven surface high pressure piston (calculated)

** Displacement volume per double stroke (calculated).

*** Static outlet pressure (calculated and maximum allowed)

**** Approximate flow at an air drive of 6 bar / 87 psi and an outlet pressure of 0 bar/psi.

ⓘ High pressure pumps with outlet connections type BSPP or NPT are suitable for outlet pressures of up to 1,050 bar (15,000 psi). For higher outlet pressures, the pumps must be ordered with high pressure connections according to the required pressure range.

series up to 1,450 bar (21,000 psi)

All high-pressure pumps from the GSF series are suitable for use in zone 1, category 2G/2D IIB TX explosion-proof areas (temperature class depending on medium temperature).



GSF-Pumps

- » Single-acting
- » With one air drive piston
- » Operating pressures of up to 1,450 bar (21,000 psi)

Due to their robust construction, GSF ideally satisfy the requirements for applications in the chemical industry.

- Material: GSF pump heads and pistons made of stainless steel
- Standard design with bottom inlet
- Maximum air drive pressure: 10 bar (145 psi)
- Distance piece and leakage borehole
- PTFE seal material

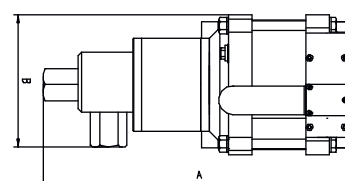
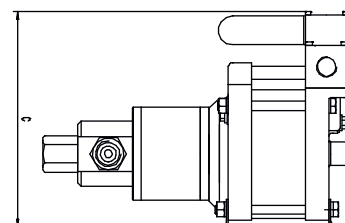

Options for GSF pumps

- Seal versions for special media
Order code: See media compatibility guide
- Side inlet:
Order code: GSF35-S
- Special connections, e.g. with NPT thread
Order code: G35(L) - NPT
- Air control unit for GSF pumps, consisting of a filter/pressure regulator combination, control pressure gauge and shut-off valve
Order code: GSF35 with C2
- Air control unit as above with additional safety valve in the air drive line for limiting the operating pressure on the high-pressure side - **Order code: GSF35 with C2/SVAir (Please indicate the operating pressure to be set.)**

Type	Pressure ratio*	Displ. Volume **		Outlet pressure ***		Flow capacity l/min ****	Connections			Dimensions in mm			Weight kg
		cm ³	cu.inch	bar	psi		Air Drive L	Inlet A	Outlet B	A	B	C	
GSF10	1:11	90.0	5.49	110	1595	18.53	3/4 BSPP	1 BSPP	3/4 BSPP	411	190,5	272	20.0
GSF15	1:16	62.0	3.78	160	2320	12.86	3/4 BSPP	1 BSPP	3/4 BSPP	411	190,5	272	20.0
GSF25	1:28	35.3	2.15	280	4260	7.24	3/4 BSPP	3/4 BSPP	3/4 BSPP	400	181	272	19.0
GSF35	1:40	24.5	1.49	400	5800	5.02	3/4 BSPP	3/4 BSPP	3/4 BSPP	400	181	272	19.0
GSF60	1:63	15.7	0.96	630	9135	3.21	3/4 BSPP	3/4 BSPP	1/2 BSPP	412	181	272	18.0
GSF100	1:113	8.8	0.54	1050	15225	1.81	3/4 BSPP	3/4 BSPP	1/2 BSPP	412	181	272	18.0
GSF150	1:151	6.6	0.40	1450	21025	1.36	3/4 BSPP	3/4 BSPP	1/2 BSPP ①	412	181	272	18.0

Chemical and offshore industries – GPD series

Maximator pumps of the GPD series are available in double-acting design with one or two air drive pistons. They are suitable for use in zone 1, category 2G/2D IIC TX explosion-proof areas (temperature class depending on medium temperature).

GPD-Pumps

- » Double-acting
- » With one air drive piston
- » Operating pressures of up to 2,770 bar (40,200 psi)

GPD pumps are distinguished by their high pump capacity with oil, water or different chemicals. They are optimally suited for testing pipelines, charging hydraulic accumulators or actuating subsea valves. Due to their high-quality materials, they are corrosion-resistant and can be used in a large number of applications in the oil and gas industry, the petrochemical industry and in general mechanical engineering.

- Pump capacity: up to 48 l/min
- Standard models with UHMWPE seal and FKM O-rings
- Only available with side inlet
- Maximum air drive pressure 10 bar (145 psi)

Thanks to their smart design, the GPD pumps allow fast, easy maintenance. Their safe operation is ensured through the separation of the drive section from the high-pressure section by the distance piece, preventing potential contamination of the environment.

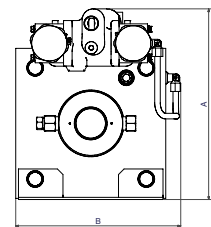
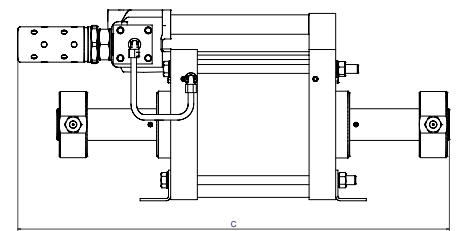
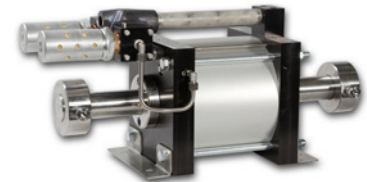

Type	Pressure ratio*	Displ. Volume **		Outlet pressure ***		Flow capacity /min ****	Connections			Dimensions in mm			Weight kg
		cm ³	cu.inch	bar	psi		Air Drive L	Inlet A	Outlet B	A	B	C	
GPD30	1:30	508	31.0	300	4350	48.0	3/4 BSPP	3/4 BSPP	3/4 BSPP	343	300	777	58
GPD60	1:60	257	15.7	600	8700	22.0	3/4 BSPP	3/4 BSPP	3/4 BSPP	343	300	777	58
GPD120	1:129	121	7.4	1200	17400	11.2	3/4 BSPP	3/4 BSPP	13/16-16 UNF (9M)	343	300	777	58
GPD180	1:192	69	4.2	1920	27840	7.5	3/4 BSPP	1/4 BSPP	3/4-16 UNF (6H)	343	300	777	58
GPD260	1:277	48	2.9	2770	40165	4.8	3/4 BSPP	1/4 BSPP	3/4-16 UNF (6H)	343	300	777	58

* Ratio – driving surface air drive piston / driven surface high pressure piston (calculated)

** Displacement volume per double stroke (calculated).

*** Static outlet pressure (calculated and maximum allowed)

**** Approximate flow at an air drive of 6 bar / 87 psi and an outlet pressure of 0 bar/psi.

ⓘ High pressure pumps with outlet connections type BSPP or NPT are suitable for outlet pressures of up to 1,050 bar (15,000 psi). For higher outlet pressures, the pumps must be ordered with high pressure connections according to the required pressure range.

up to 3,000 bar (43,500 psi)



GPD-2-Pumps

- » Double-acting
- » With two air drive pistons
- » Operating pressures of up to 3,000 bar (43,500 psi)

Options for GPD pumps

- Air control unit for GPD pumps, consisting of a filter/pressure regulator combination, control pressure gauge and shut-off valve
Order code: GPD30 with C3
- Air control unit as above with additional safety valve in the air drive line for limiting the operating pressure on the high-pressure side - **Order code: GPD30 with C3/SVAir (Please indicate the operating pressure to be set.)**

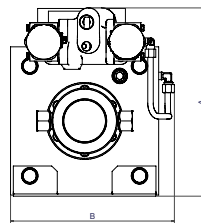
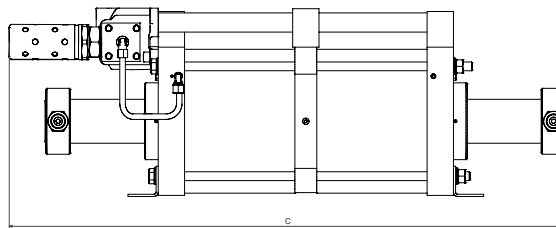

Type	Pressure ratio*	Displ. Volume **		Outlet pressure ***		Flow capacity l/min ****	Connections			Dimensions in mm			Weight kg
		cm ³	cu.inch	bar	psi		Air Drive L	Inlet A	Outlet B	A	B	C	
GPD30-2	1:60	508	31.0	600	8700	25.5	3/4 BSPP	3/4 BSPP	3/4 BSPP	343	300	1016	78
GPD60-2	1:120	257	15.7	1200	17400	13.0	3/4 BSPP	3/4 BSPP	3/4 BSPP ⓘ	343	300	1016	78
GPD120-2	1:258	121	7.4	2580	37400	7.0	3/4 BSPP	3/4 BSPP	13/16-16 UNF (9M) ⓘ	343	300	1016	78
GDP180-2	1:384	69	4.2	3000	43500	4.4	3/4 BSPP	1/4 BSPP	3/4-16 UNF (6H)	343	300	1016	78
GPD260-2	1:554	48	2.9	3000	43500	2.85	3/4 BSPP	1/4 BSPP	3/4-16 UNF (6H)	343	300	1016	78

Chemical and offshore industries – GX series up to 1,000 bar (14,500 psi)

All high-pressure pumps from the GX series are suitable for use in zone 1, category 2G/2D IIC TX explosion-proof areas (temperature class depending on medium temperature).

GX-Pumps

» Operating pressures of up to 1,000 bar (14,500 psi)

The GX pumps are distinguished by their high pump capacity. Their robust construction, stainless-steel wetted parts and high resistance to corrosion air drive section make them ideal for the rough operating conditions in the offshore industry.

- Material: Stainless-steel pump heads and pistons
- Standard models with UHMWPE seals and FKM O-ring

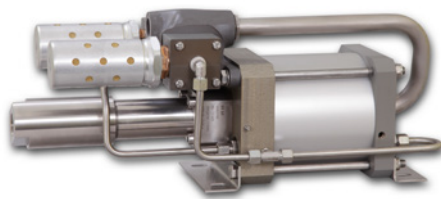
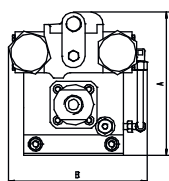
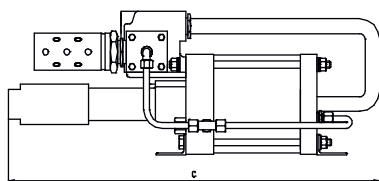

Options for GX pumps

- UHMWPE seals and optionally available with (depending on medium used):
 - FKM O-Ring **Order code: GX35 - FKM**
 - NBR O-Ring **Order code: GX35 - NBR**
 - EPDM O-Ring **Order code: GX35 - EPDM****See media compatibility guide**
- Air control unit for GX pumps, consisting of a filter/pressure regulator combination, control pressure gauge and shut-off valve
Order code: GX35 with C3
- Air control unit as above with additional safety valve in the air drive line for limiting the operating pressure on the high-pressure side - **Order code: GX with C3/SVAir (Please indicate the operating pressure to be set.)**

Other options available on request.

Type	Pressure ratio*	Displ. Volume **		Outlet pressure ***		Flow capacity l/min ****	Connections			Dimensions in mm			Weight kg
		cm ³	cu.inch	bar	psi		Air Drive L	Inlet A	Outlet B	A	B	C	
GX35	1:36	110	6.71	360	5220	24.50	3/4 BSPP	1 FNPT	3/8 FNPT	237	244	632	24.0
GX60	1:66	65	3.97	600	8700	23.00	3/4 BSPP	1 FNPT	3/8 FNPT	237	244	632	24.0
GX100	1:117	36	2.20	1000	14500	9.00	3/4 BSPP	1 FNPT	3/8 FNPT	237	244	632	24.0
GX170	1:177	36	2.20	1000	14500	5.50	3/4 BSPP	1 FNPT	3/8 FNPT	274	249	622	30.0

* Ratio – driving surface air drive piston / driven surface high pressure piston (calculated)

** Displacement volume per double stroke (calculated).

*** Static outlet pressure (calculated and maximum allowed)

**** Approximate flow at an air drive of 6 bar / 87 psi and an outlet pressure of 0 bar/psi.

Special pumps

DPD series up to 2,100 bar (30,500 psi)



DPD-Pumps

» Operating pressures of up to 2,100 bar (30,500 psi)

DPD pumps are large pumps with high pump capacities working at high operating pressures of up to 2,100 bar (30,450 psi). The pumps are double-acting and available in two different pressure ratios.

Options for DPD pumps

- Air control unit for DPD pumps, consisting of a filter/pressure regulator combination, control pressure gauge and shut-off valve
Order code: DPD150 with C3
- Air control unit as above with additional safety valve in the air drive line for limiting the operating pressure on the high-pressure side - **Order code: DPD with C2/SVAir (Please indicate the operating pressure to be set.)**

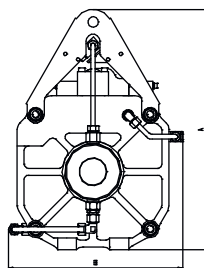
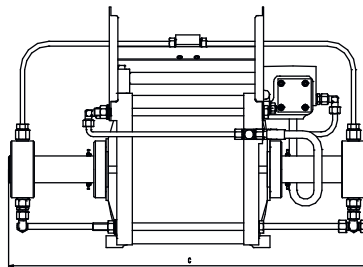

Type	Pressure ratio*	Displ. Volume **		Outlet pressure ***		Flow capacity I/min ****	Connections			Dimensions in mm			Weight kg
		cm ³	cu.inch	bar	psi		Air Drive L	Inlet A	Outlet B	A	B	C	
DPD150	1:185	72	4.4	1500	21750	8.00	3/4 BSPP	3/8 BSPP	1 1/18-12 UNF	460	346	762	54.0
DPD200	1:268	72	4.4	2100	30450	2.11	3/4 BSPP	3/8 BSPP	1 1/18-12 UNF	460	346	762	54.0

Pump design

Besides weight and dimensions, selecting the right pump for your application is based essentially on the required operating pressure as well as the pump capacity. Essentially, three different applications must be distinguished in order to calculate the pump capacity:

1. Continuous flow rate at defined pressure

With such applications, e.g. continuous cooling or flushing of systems, the pump capacity is generally calculated from the application.

$$Q = \frac{A_z \times h_z \times n}{\text{min}} \text{ in [l/min]}$$

A_z = piston area cylinder in [dm²]

h_z = piston travel cylinder in [dm]

n = number of actuations per minute

The following applies for unfilled test items:

$$Q = \frac{V + (\chi \times \Delta P \times V)}{T_D} \text{ in [l/min]}$$

The following applies for prefilled test items:

$$Q = \frac{(\chi \times \Delta P \times V)}{T_D} \text{ in [l/min]}$$

V = test volume in [l]

χ = modulus of compressibility of test medium in [1/GPa]
(e.g. water 0,5*1/GPa)

ΔP = test pressure in GPa
(1000 bar = 0,1 GPa)

T_D = time for pressure build-up in [min]

2. Actuation of hydraulic cylinders

The decisive criteria here are: the fill volume of the cylinder, the cylinder actuation time and the number of actuations per minute. The following formula can be used to calculate the required pump capacity Q:

3. Pressure test of test items with defined volumes

When executing a pressure test on components pressurised internally, the most important variables are the pressure build-up time, the volume of the test item, the modulus of compressibility of the test medium and the pressure.

Pump selection

Selecting the most suitable pump is a two-step process:

Step 1: Selection of pump series

First you make a selection of the pump series in the diagram (right) based on the operating pressure and the pump capacity required for your application. The characteristics shown (diagonals) are based on an air drive pressure of 6 bar.

Example: The operating pressure of your example application is 600 bar and the pump capacity 1.0 l/min. The process parameter combination is marked in the diagram as a grey point. Only those pump series are suitable for your application whose characteristics are located in the window at the upper right of the point (rectangle in the diagram). In order to avoid over-dimensioning, select the pump series nearest to the point: in this case, the G...D pumps.

Step 2: Pump selection

The pump selection is now made based on the pump capacity tables on pages 27-33. In this example, the G150D would meet the desired performance parameters.

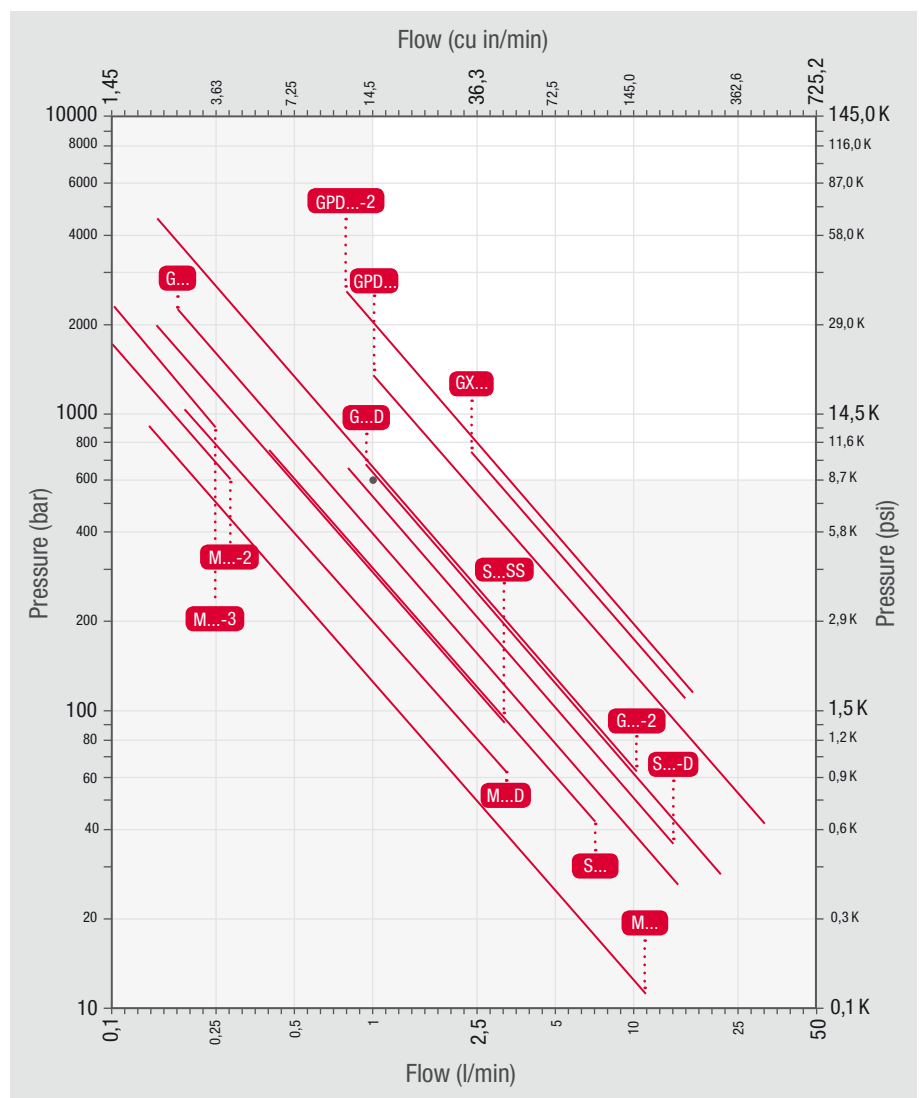

The performance data indicated here were determined with optimal flow cross-sections and the required volume flow for driving air.

Pump capacities

Pump capacities of M-, MO- and MSF-Series

Pump type	Air Drive pressure in bar	Outlet pressure in bar								
		0/Atm	50	100	500	1000	1500	2000	3000	4000
M[(O)(SF)]4	4	14.51								
	6	14.81								
	8	14.93								
M[(O)(SF)]8	4	6.93								
	6	7.07	0.89							
	8	7.13	3.39							
M[(O)(SF)]12	4	4.46	0.71							
	6	4.55	2.64							
	8	4.59	3.43	0.84						
M[(O)(SF)]22	4	2.17	1.58	0.44						
	6	2.22	1.92	1.33						
	8	2.24	2.05	1.70						
M[(O)(SF)]37	4	1.34	1.15	0.84						
	6	1.36	1.27	1.11						
	8	1.38	1.32	1.22						
M[(O)(SF)]72	4	0.71	0.67	0.60						
	6	0.72	0.7	0.67	0.06					
	8	0.73	0.72	0.70	0.33					
M[(O)(SF)]111	4	0.47	0.45	0.43	0.05					
	6	0.48	0.47	0.46	0.26					
	8	0.48	0.48	0.47	0.35	0.05				
M[(O)(SF)]189	4	0.28	0.27	0.26	0.17					
	6	0.28	0.28	0.28	0.23	0.11				
	8	0.28	0.28	0.28	0.25	0.18	0.08			
M111-2	4	0.35	0.34	0.33	0.24	0.03				
	6	0.35	0.35	0.35	0.30	0.19	0.04			
	8	0.36	0.35	0.35	0.32	0.26	0.16	0.04		
M189-2	4	0.20	0.20	0.20	0.18	0.12	0.05			
	6	0.21	0.21	0.21	0.19	0.17	0.13	0.08		
	8	0.21	0.21	0.21	0.20	0.19	0.16	0.14	0.06	
M111-3	4	0.23	0.23	0.23	0.19	0.12	0.02			
	6	0.24	0.23	0.23	0.22	0.18	0.13	0.06		
	8	0.24	0.24	0.24	0.23	0.20	0.17	0.13	0.03	
M189-3	4	0.14	0.14	0.13	0.12	0.11	0.08	0.05		
	6	0.14	0.14	0.14	0.13	0.12	0.11	0.10	0.06	0
	8	0.14	0.14	0.14	0.14	0.13	0.12	0.11	0.09	0.06
M4D	4	24,6								
	6	25,1								
	8	25,3								
M8D	4	11,7								
	6	12	0,1							
	8	12,1	4,3							
M12D	4	7,6	1,3							
	6	7,7	4,5							
	8	7,8	5,9	1,4						
M(O)22D	4	3.83	2.75	0.66						
	6	3.91	3.36	2.29						
	8	3.94	3.61	2.96						
M(O)37D	4	2.31	1.99	1.45						
	6	2.35	2.20	1.92						
	8	2.37	2.28	2.11						
M(O)72D	4	1.22	1.15	1.04						
	6	1.24	1.21	1.15	0.11					
	8	1.26	1.23	1.20	0.57					
M(O)111D	4	0.81	0.78	0.74	0.08					
	6	0.82	0.81	0.79	0.45					
	8	0.83	0.82	0.81	0.60	0.09				
M(O)189D	4	0.48	0.47	0.45	0.29					
	6	0.49	0.48	0.48	0.39	0.20	0.06			
	8	0.49	0.49	0.48	0.43	0.32	0.14			

Capacity in l/min

Pump capacities

Pump capacities of S- and S...SS-Series

Pump type	Air Drive pressure in bar	Outlet pressure in bar									
		0/Atm	50	100	200	300	400	500	600	700	800
S15	4	9.11	3.82								
	6	9.38	6.60	0.91							
	8	9.50	7.78	4.28							
S25	4	6.59	4.39	0							
	6	6.72	5.60	3.36							
	8	6.78	6.10	4.74	0						
S35	4	4.22	3.48	2.16							
	6	4.31	3.93	3.26	1.03						
	8	4.34	4.12	3.71	2.36	0.30					
S60	4	2.70	2.44	2.03	0.75						
	6	2.75	2.62	2.41	1.76	0.80					
	8	2.78	2.70	2.57	2.18	1.60	0.83				
S100	4	1.52	1.45	1.35	1.07	0.68	0.19				
	6	1.55	1.51	1.46	1.32	1.12	0.87	0.57	0.20		
	8	1.56	1.54	1.51	1.42	1.30	1.15	0.97	0.75	0.50	0.21
S150	4	1.05	1.02	0.98	0.80	0.64	0.44	0.20			
	6	1.08	1.06	1.04	0.98	0.91	0.81	0.70	0.57	0.42	0.26
	8	1.08	1.07	1.06	1.03	0.98	0.93	0.86	0.78	0.69	0.59
S15D	4	17.21	6.17								
	6	17.56	11.93								
	8	17.71	14.30	6.78							
S25D	4	11.76	7.59								
	6	12.00	9.87	5.58							
	8	12.10	10.81	8.21							
S35D	4	7.43	6.08	3.66							
	6	7.58	6.89	5.65	1.54						
	8	7.64	7.22	6.48	3.99	0.18					
S60D	4	4.70	4.24	3.51	1.22						
	6	4.80	4.56	4.20	3.02	1.30					
	8	4.84	4.70	4.47	3.28	2.07	0.53				
S100D	4	2.62	2.50	2.33	1.84	1.16	0.30				
	6	2.68	2.62	2.53	2.28	1.93	1.49	0.95	0.32		
	8	2.70	2.66	2.61	2.46	2.25	1.98	1.66	1.27	0.83	0.33
S150D	4	1.82	1.76	1.69	1.50	1.24	0.92	0.54	0.10		
	6	1.85	1.83	1.79	1.69	1.56	1.40	1.20	0.98	0.72	0.43
	8	1.87	1.85	1.83	1.77	1.69	1.59	1.48	1.34	1.18	0.91
Pump type	Air Drive pressure in bar	Outlet pressure in bar									
		0/Atm	50	100	250	500	1000	1500	2000	2500	2800
S40-SS	4	3.88	3.21	2.05							
	6	3.95	3.62	3.03							
	8	3.99	3.79	3.43	1.41						
S80-SS	4	1.94	1.81	1.61	0.64						
	6	1.97	1.91	1.81	1.32						
	8	1.99	1.96	1.89	1.59	0.71					
S160-SS	4	0.97	0.94	0.90	0.74	0.32					
	6	0.99	0.97	0.95	0.87	0.66					
	8	1.00	0.99	0.98	0.93	0.80	0.35				
S200-SS	4	0.78	0.76	0.73	0.64	0.41					
	6	0.79	0.78	0.77	0.73	0.61	0.21				
	8	0.80	0.79	0.78	0.76	0.68	0.45	0.09			
S250-SS	4	0.62	0.61	0.60	0.54	0.41	0				
	6	0.63	0.63	0.62	0.59	0.53	0.31	0			
	8	0.64	0.64	0.63	0.61	0.57	0.44	0.25	0		
S350-SS	4	0.44	0.44	0.43	0.40	0.35	0.18				
	6	0.45	0.45	0.45	0.43	0.40	0.32	0.19	0.03		
	8	0.46	0.46	0.45	0.44	0.42	0.37	0.30	0.20	0.08	0

Capacity in l/min

Pump capacities of G-, GSF- and G...D-Series

Pump type	Air Drive pressure in bar	Outlet pressure in bar								
		0/Atm	50	100	500	1000	1500	2000	3000	4000
G(SF)10	4	18.16								
	6	18.53	7.22							
	8	18.68	11.84							
G(SF)15	4	12.60	4.19							
	6	12.86	8.57							
	8	12.96	10.37	4.61						
G(SF)25	4	7.10	5.14	1.35						
	6	7.24	6.24	4.31						
	8	7.30	6.70	5.53						
G(SF)35	4	4.92	4.11	2.70						
	6	5.02	4.61	3.89						
	8	5.06	4.82	4.38						
G(SF)60	4	3.15	2.86	2.41						
	6	3.21	3.07	2.84						
	8	3.24	3.15	3.01	0.14					
G(SF)100	4	1.77	1.69	1.58						
	6	1.81	1.77	1.71	0.75					
	8	1.82	1.80	1.76	1.18					
G(SF)150	4	1.33	1.29	1.00						
	6	1.36	1.34	1.19	0.38					
	8	1.37	1.36	1.34	1.07	0.40				
G250	4	0.76	0.74	0.73	0.53	0.08				
	6	0.77	0.76	0.76	0.66	0.42	0.08			
	8	0.78	0.77	0.77	0.70	0.57	0.36	0.08		
G300	4	0.64	0.63	0.62	0.49	0.02				
	6	0.65	0.65	0.64	0.57	0.43	0.22			
	8	0.66	0.65	0.65	0.61	0.52	0.39	0.22		
G400	4	0.50	0.50	0.49	0.42	0.27	0.05			
	6	0.51	0.51	0.50	0.47	0.39	0.28	0.14		
	8	0.52	0.52	0.51	0.49	0.44	0.38	0.29	0.06	
G500	4	0.39	0.38	0.38	0.34	0.27	0.16	0.03		
	6	0.39	0.39	0.39	0.37	0.33	0.28	0.21	0.03	
	8	0.40	0.40	0.39	0.38	0.36	0.33	0.29	0.18	0.03
Pump type	Air Drive pressure in bar	Outlet pressure in bar								
		0/Atm	25	50	100	250	500	750	1000	
G10D	4	28.28	16.84							
	6	28.85	23.02	10.97						
	8	29.09	25.56	18.27						
G15D	4	19.44	14.93	6.47						
	6	19.84	17.54	13.22						
	8	20.00	18.61	16.00	7.11					
G25D	4	10.11	9.91	7.98	1.90					
	6	11.34	10.73	9.74	6.64					
	8	11.43	11.06	10.46	8.59					
G35D	4	7.59	7.08	6.35	4.16					
	6	7.74	7.48	7.11	6.00					
	8	7.80	7.65	7.42	6.75	2.99				
G60D	4	4.94	4.74	4.48	3.77	0.07				
	6	5.04	4.94	4.81	4.44	2.55				
	8	5.08	5.02	4.94	4.72	3.58	0.07			
G100D	4	2.73	2.67	2.61	2.44	1.68				
	6	2.78	2.76	2.72	2.64	2.25	1.16			
	8	2.81	2.79	2.77	2.72	2.48	1.82			
G150D	4	2.06	2.03	1.99	1.91	1.54	0.55			
	6	2.10	2.09	2.07	2.02	1.84	1.33	0.59		
	8	2.12	2.11	2.10	2.07	1.96	1.65	1.20	0.61	

Capacity in l/min

Pump capacities

Pump capacities of G...-2-Series

Pump type	Air Drive pressure in bar	Outlet pressure in bar								
		0/Atm	50	100	500	1000	1500	2000	3000	4000
G10-2	4	15.57	9.36							
	6	15.89	12.72	6.19						
	8	16.02	14.10	10.15						
G15-2	4	10.08	8.30	3.59						
	6	11.02	9.74	7.34						
	8	11.11	10.34	8.89						
G25-2	4	6.06	5.43	4.40						
	6	6.19	5.86	5.34						
	8	6.24	6.04	5.72						
G35-2	4	4.21	3.94	3.53						
	6	4.30	4.16	3.95						
	8	4.34	4.25	4.12	1.66					
G60-2	4	2.70	2.59	2.46	0.10					
	6	2.76	2.70	2.63	1.43					
	8	2.78	2.75	2.70	1.98	0.12				
G100-2	4	1.52	1.49	1.45	0.94					
	6	1.55	1.53	1.51	1.25	0.64				
	8	1.56	1.55	1.54	1.27	1.01	0.46			
G150-2	4	1.14	1.12	1.10	0.85	0.31				
	6	1.16	1.16	1.15	1.02	0.74	0.33			
	8	1.17	1.17	1.16	1.09	0.92	0.67	0.34		
G250-2	4	0.65	0.64	0.64	0.57	0.45	0.28	0.07		
	6	0.66	0.66	0.66	0.62	0.56	0.47	0.36	0.07	
	8	0.67	0.67	0.66	0.64	0.61	0.55	0.49	0.31	0.07
G300-2	4	0.55	0.54	0.54	0.50	0.42	0.31	0.17		
	6	0.56	0.56	0.55	0.53	0.49	0.44	0.37	0.19	
	8	0.56	0.56	0.56	0.55	0.52	0.49	0.45	0.34	0.19
G400-2	4	0.43	0.43	0.42	0.38	0.33	0.27	0.19		
	6	0.44	0.44	0.44	0.42	0.39	0.36	0.32	0.21	0.08
	8	0.44	0.44	0.44	0.44	0.42	0.40	0.38	0.32	0.25
G500-2	4	0.33	0.33	0.33	0.31	0.29	0.26	0.23	0.16	0.05
	6	0.34	0.34	0.34	0.33	0.32	0.30	0.28	0.24	0.18
	8	0.34	0.34	0.34	0.34	0.33	0.32	0.31	0.28	0.25

Capacity in l/min

Pump capacities of GX-Series

Pump type	Air Drive pressure in bar	Outlet pressure in bar									
		0/Atm	50	100	200	300	400	500	600	700	800
GX35	4	29.40	14.90	6.00							
	6	34.20	20.90	12.60	1.40						
	8	37.50	25.00	17.30	6.70						
GX60	4	16.00	11.10	7.60	2.50						
	6	18.60	14.10	10.90	6.20	2.70					
	8	20.40	16.20	13.20	8.80	5.50	2.80	0.50			
GX100	4	9.00	7.30	6.00	3.80	2.20	0.80				
	6	10.50	8.90	7.70	5.70	4.20	2.90	1.80	0.90	0	
	8	11.50	10.00	8.90	7.00	5.60	4.40	3.40	2.50	1.60	0.90
GX170	4	5.50	5.40	5.20	4.75	4.10	3.30	2.40	1.30	0	
	6	5.60	5.60	5.50	5.25	4.95	4.54	4.06	3.50	2.89	2.19
	8	5.70	5.68	5.62	5.47	5.27	5.03	4.75	4.42	4.04	3.62

Capacity in l/min

Pump capacities of GPD-Series

Pump type	Air Drive pressure in bar	Outlet pressure in bar									
		0/Atm	50	100	250	500	1000	1500	2000	2500	3000
GPD30	4	42.00	22.00	5.00							
	6	46.00	30.00	17.00							
	8	48.00	35.00	24.00							
GPD60	4	18.00	13.50	9.50							
	6	20.00	16.50	13.00	5.00						
	8	21.00	18.00	15.50	8.50						
GPD120	4	9.60	8.38	7.20	4.10						
	6	10.60	9.62	8.70	6.24	2.70					
	8	11.20	10.38	9.60	7.54	4.60					
GPD180	4	6.40	5.86	5.32	3.84	1.69					
	6	7.09	6.63	6.21	5.04	3.34	0.42				
	8	7.48	7.10	6.74	5.76	4.34	1.89				
GPD260	4	4.18	3.93	3.70	3.04	2.06	0.34				
	6	4.60	4.41	4.22	3.70	2.92	1.57	0.36			
	8	4.86	4.70	4.54	4.10	3.45	2.31	1.30	0.38		
GPD30-2	4	22.30	16.80	12.00							
	6	24.60	20.20	16.40	6.70						
	8	25.90	22.30	19.10	10.9						
GPD60-2	4	11.30	9.82	8.48	4.88						
	6	12.40	11.27	10.20	7.37	3.32					
	8	13.10	12.15	11.25	8.88	5.49					
GPD120-2	4	5.34	5.00	4.68	3.79	2.45	0.13				
	6	5.88	5.61	5.36	4.65	3.60	1.76	0.14			
	8	6.21	5.98	5.77	5.18	4.29	2.75	1.40	0.15		
GPD180-2	4	3.83	3.65	3.48	3.01	2.28	1.01				
	6	4.21	4.07	3.94	3.56	2.99	1.98	1.08	0.25		
	8	4.45	4.33	4.22	3.90	3.42	2.58	1.82	1.12	0.47	
GPD260-2	4	2.48	2.41	2.34	2.13	1.81	1.22	0.69	0.20		
	6	2.74	2.68	2.62	2.45	2.20	1.74	1.32	0.93	0.56	0.21
	8	2.89	2.84	2.79	2.65	2.44	2.05	1.70	1.37	1.07	0.77

Capacity in l/min

Pump capacities of DPD-Series

Pump type	Air Drive pressure in bar	Outlet pressure in bar								
		0/Atm	50	100	500	1000	1250	1500	1750	2000
DPD150	4	8.10	7.93	7.67	3.82					
	6	8.30	8.19	8.06	6.10	1.37				
	8	8.37	8.30	8.22	7.04	4.18	2.61			
DPD200	4	2.06	2.03	1.99	1.44	0.22				
	6	2.11	2.09	2.07	1.79	1.17	0.75	0.22		
	8	2.12	2.11	2.10	1.93	1.55	1.30	1.00	0.65	0.25

Capacity in l/min

Media compatibility guide

Seal version	Seal material	Remarks	Temperature
without indication or „L”	Polyurethane (PU) Nitrile (NBR)	Standard	-20°C - +80°C
VE	Polyethylene (UHMWPE) Flourcarbon (V)	Standard	-20°C - +60°C
VE / NBR	Polyethylene (UHMWPE) Nitrile (NBR)	Special	-20°C - +60°C
VE / EPR	Polyethylene (UHMWPE) Ethylene Propylen	Special	-20°C - +60°C
VE / CRL	Polyethylene (UHMWPE) Chloropren (CRL)	Special	-20°C - +60°C
VE / KAL	Polyethylene (UHMWPE) Kalrez (KAL)	Special	-20°C - +60°C
SF	Filled Teflon (PTFE) Flourcarbon (V)	Standard	-20°C - +60°C

Medium	Seal version						
	Standard L	Standard VE	Special VE / NBR	Special VE / EPR	Special VE / CRL	Special VE / KAL	Pump Series MSF and GSF
A	Acetone			•		•	•
	Ammonia			•	•		•
	Ammonium Chloride	•	•	•	•	•	•
	Ammonium Hydroxide			•	•	•	•
	Ammonium Nitrate			•	•	•	•
	Ammonium Sulfate			•	•	•	•
	ASTM Oil No. 1	•	•	•		•	•
	ASTM Oil No. 2		•	•		•	•
	ASTM Oil No. 3		•	•		•	•
	ASTM Oil No. 4	•				•	•
B	Barium Chloride	•	•	•	•	•	•
	Barium Hydroxide		•	•	•		•
	Barium Sulfide	•	•	•	•		•
	Benzol		•			•	•
	Bleaching Lye		•	•			•
	Borax	•	•	•			•
	Boric Acid	•	•	•	•	•	•
	Brake Fluid			•		•	•
	Bromobenzene		•				•
	Bromine Water		•				•
	Bunker Fuel		•	•			•
	Butadiene		•			•	•
	Butanol		•		•	•	•
	Butyl Acetate					•	•
C	Calcium Carbonate		•	•	•		•
	Calcium Chloride	•	•	•	•	•	•
	Calcium Hydroxide		•	•	•		•
	Calcium Hypochloride		•	•			•
	Calcium Phosphate	•	•	•			•
	Calcium Silicate		•	•			•
	Calcium Sulfide		•	•	•		•
	Carbon Dioxide			•		•	•
	Cellugard		•	•	•		•
	Cetane		•	•			•
	Chloracetone			•			•
	Chromic alum		•	•	•		•
	Citric Acid		•	•	•	•	•
	Cotton Oil		•	•			•
	Copper Chloride	•	•	•			•
D	Diacetone Alcohol			•			•
	Diethylene Glycol		•	•	•		•
	Drilling Oil	•	•	•		•	•
E	Etheric Oils						•
	Ethyl Acetate					•	•
	Ethyl Alcohol		•	•	•	•	•
	Ethyl Chloride						•
	Ethyl Glycol		•	•	•	•	•
F	Fatty Acids	•	•				•
	Ferric Chloride	•	•	•		•	•
	Fluorosilicic acid		•	•			•
	Freon				•		•
	Fuel	•	•	•		•	•
	Fuel Oil		•	•		•	•
G	Gelatin		•	•			•

Medium	Seal version						Pump Series MSF and GSF
	Standard L	Standard VE	Special VE / NBR	Special VE / EPR	Special VE / CRL	Special VE / KAL	
G	Glucose		•	•	•		•
	Glycerine	•	•	•	•	•	•
	Glycol	•	•	•	•	•	•
H	Halon	•		•			•
	Hexyl Alcohol		•	•			•
	Hydraulic Oils (Petroleum)	•	•	•		•	•
	Hydrazine				•		•
	Hydrogen Peroxide		•			•	•
	Hydrolube		•	•			•
	Hydrocyanic acid		•	•			•
I	Iso-Butyl Alcohol		•		•	•	•
	Isopropanol		•		•	•	•
	Isopropyl Alcohol		•		•		•
K	Kerosene	•	•			•	•
L	Lead Nitrate			•		•	•
	Lead Sulphate		•		•	•	•
	Light Crude Oil		•	•		•	•
	Lindol (hydraulic fluids)			•			•
	Linseed Oil		•	•			•
	Liquid Gas (Propane/Butane)		•	•		•	•
M	Methane		•			•	•
	Methyl Alcohol			•		•	•
	Methyl Carbonate		•				•
	Methyl Chloride					•	•
	Mineral Oils	•	•	•		•	•
	Mobil Oil SAE 20	•	•	•		•	•
N	Natural Oil		•			•	•
P	Paraffin Oil		•	•		•	•
	Pentane		•	•		•	•
	Phenol					•	•
	Petrol		•	•		•	•
	Petrol "Super"		•	•		•	•
	Phosphate Esters			•			•
	Potassium Acetate			•			•
	Potassium Chloride	•	•	•	•	•	•
	Potassium Nitrate	•	•	•	•	•	•
	Potassium Sulfate	•	•	•	•	•	•
	Propane		•	•		•	•
	Propyl Alcohol		•	•	•		•
S	Salt Water		•	•		•	•
	Silicone Oils	•	•	•	•	•	•
	Skydrol			•		•	•
	Soap Water		•	•			•
	Sodium Acetate			•		•	
	Sodium Bisulfate	•	•	•	•		•
	Sodium Carbonate		•	•	•	•	•
	Sodium Chloride	•	•	•	•	•	•
	Sodium Peroxide		•	•		•	•
	Sodium Sulfide	•	•	•	•	•	•
	Sugar Liquids		•	•	•		•
T	Tartaric Acid		•	•			•
	Tetrachlorethylene		•			•	•
	Tetralin		•			•	•
	Toluol					•	•
	Trichlorethylene		•			•	•
	Turbine Oil	•	•	•		•	•
	Turpentine		•	•		•	•
	Turpentine Oil		•				•
V	Vegetable Oils		•	•		•	•
	Vinegar		•	•	•		•
W	Water		•			•	•
Z	Zinc Acetate			•			•
	Zinc Chloride		•	•	•		•

Accessories

Accessories for air-driven hydraulic pumps

We also have an extensive range of accessories for the installation of your MAXIMATOR pump. This way, you can either select a pump unit which is ready for connection or individual components for manufacturing hydraulic systems at your site.

Please contact MAXIMATOR or ask for our „MAXIMATOR Hydraulic Units“ catalogue.

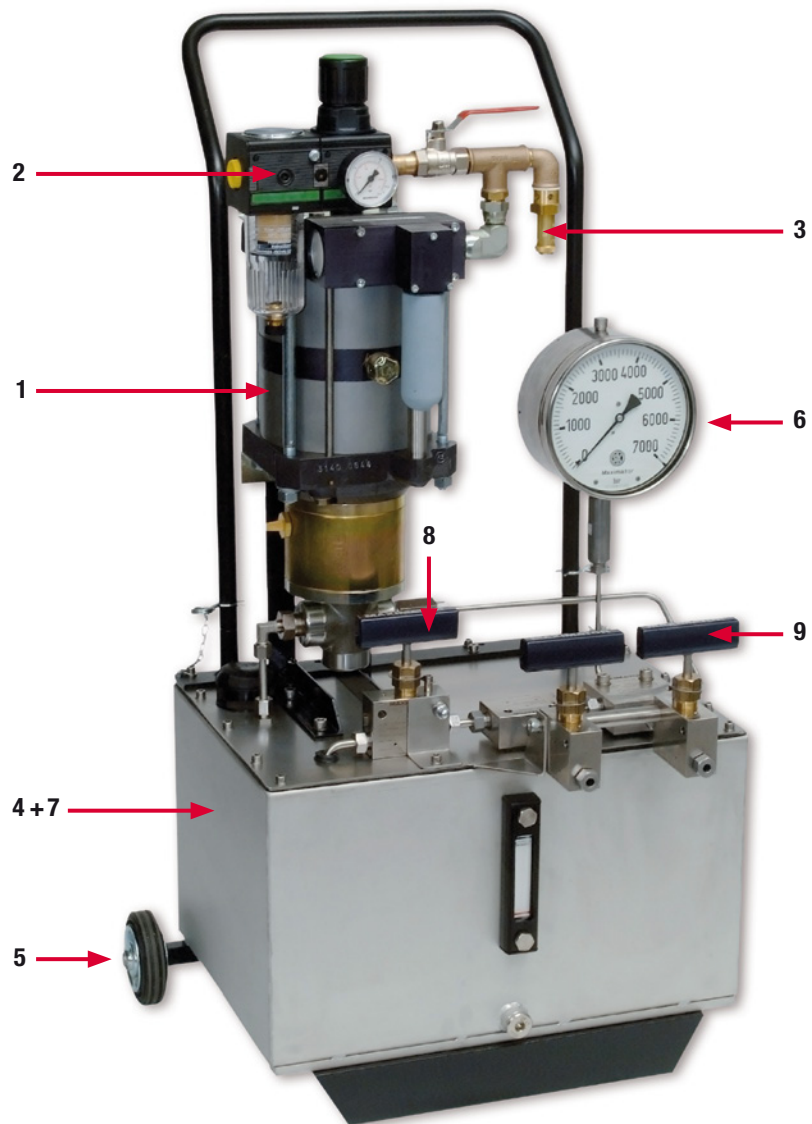

Easy operation for heavy-duty conditions

Because the devices are air-driven, all control processes are unsurpassed in their simplicity. This makes the entire device especially sturdy, reliable and insensitive to even the most extreme operating conditions.

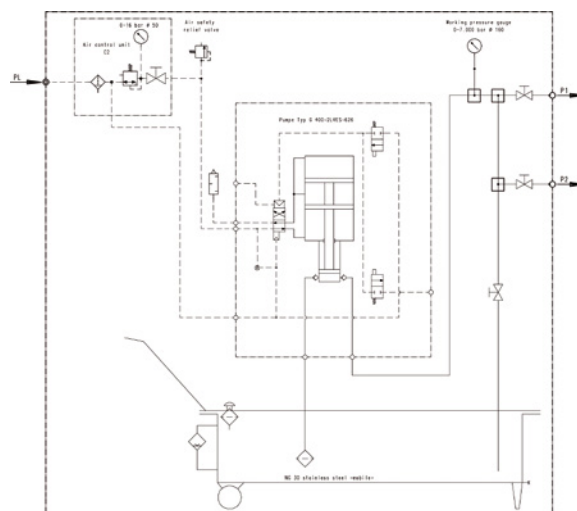

MAXIMATOR Hydraulic Units

Components in modular design:	
1 Pump model	all M-, S-, G-, GX-, GPD- and DPD-Series pumps
2 Air control unit	comprising combined filter pressure regulator, control pressure gauge and shut-off valve: C1 for M-Series C1.5 for S-Series C2 for G-Series C3 for GX-, GPD- and DPD-Series
3 Air safety valve	SV mounted in the air line
4 Tank sizes	6,5 liter, 13 liter, 30 liter, 70 liter, standard of aluminium, stainless steel on request
5 Mobility of the packaged pump system	F mobile (with wheels), T portable (with handles), K jack ring
6 Pressure gauge	Pressure range / Diameter of the housing (cl. 1.6/1.0/0.6, glycerine damped)
7 Operating medium	O Oil (tank of aluminium, components galvanized) W Water (tank of aluminium, components of stainless steel) VA Stainless steel (tank und components of stainless steel)
8 Relief valve	EV with return line to the tank
9 Manifold block with pressure outlet(s)	A1 1 pressure outlet to A6 6 pressure outlets as maximum (depending on tank size) V Option: Shut-off valve for each pressure outlet (AV1-AV6)
10 Other options:	SCHW Float valve for automatic filling of the tank, i. e. from the water line SCHL High pressure hose ZR Additional return connection
11 Specials	on request

Coding example:

G400-2/C2/SV/30/F/EV/0-7000(160)/W/AV2/VA, comprising:

G400-2 = MAXIMATOR air driven liquid pump Type G400-2

C2 = Air control unit „C2“, comprising:

- combined filter pressure regulator
- control pressure gauge
0–10 bar (ø 40 mm)
- shut-off valve

SV = Safety valve

30 = Tank size 30 liter

F = mobile (with wheels)

EV = Manually operated relief valve

0 – 7000 (160) = Pressure gauge 0 to 7000 bar, diameter 160 mm

W = for water service

AV2 = Manifold block with two pressure outlets and shut-off valves

VA = Tank of stainless steel

Additional products

» Hydraulics and pneumatics



Running reliable processes

Besides high-pressure pumps, Maximator also offers an extensive range of air-driven gas boosters for operating pressures of up to 2,400 bar. A complete series of valves, fittings and tubings for up to 10,500 bar as well as a series of accessories including pressure regulators, pressure switches, filters, coolers, pressure transducers and pressure gauges complete our selection.

In addition, we offer a wide spectrum of hydraulic units and booster stations for a very wide range of applications in the fields of general mechanical engineering, automotive engineering, the chemical industry, energy, as well as oil and gas. We also support our customers worldwide with tailor-made solutions.



Gas boosters

- Oil-free compression of industrial gases and compressed air up to 2,400 bar
- Air-driven piston boosters which operating according to the principle of a pressure intensifier
- Air-driven operation makes them particularly suitable for use in explosion-protected areas
- No power consumption during long pressure holding periods



Valves, fittings and pipes

- Engineering and manufacturing exclusively in Germany
- Extensive product range (high-pressure valves, fittings, tubings, check valves, filters, adaptors and more)
- Short delivery times thanks to highly flexible manufacturing
- Certificates available for all products (manufacturer's declaration, ATEX and more)



Hydraulic systems and gas booster stations

- Compact hydraulic units for clamping and testing applications
- Injection units and sampling systems
- Flushing stations for extreme environmental conditions

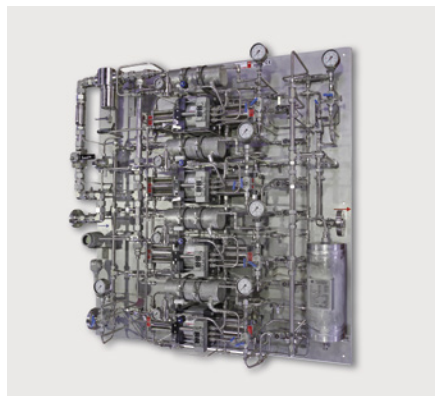

- Hydraulic systems for on- and offshore applications (Wellhead control panels, testing and supply systems for subsea control modules)
- Booster stations for increasing sealing pressure with gas-sealed mechanical seals

- Gas booster stations for testing and filling tasks
- Hydraulic units and booster stations in stainless-steel design
- Feed systems for mechanical seals

Additional products

» High-pressure technology and testing equipment



Pushing the realms of possibility

MAXIMATOR GmbH successfully develops complex systems in high-pressure and testing technology, hydraulics and pneumatics and has been the market leader in these segments for decades. As a specialist in high pressure technology up to 20,000 bar, we pursue the aim of optimally supporting each and every customer with our products to develop business potential.

With our top services, we are a partner to well-known companies in the automotive and supply industry, as well as the chemical, plastics, oil and gas industries. We give professional advice, plan projects and supply testing and manufacturing systems. We also develop special solutions precisely customised to the requirements of manufacturers.



Testing and production systems

- Autofrettage machines (20,000 bar)
- Leakage and burst pressure testing technology
- Assembly and functional test systems
- Expansion units
- Pressure pulse test machines (6,000 bar)
- High-pressure forming machines
- Testing technology for plastic components
- Testing technology for high-pressure-carrying components in hydrogen mobility



Gas and water systems for assisted injection moulding

- High-pressure nitrogen supply systems
- Gas regulation and booster stations
- Nitrogen flushing modules
- Water assisted systems
- Gas and water injectors
- Gas dosing stations
- Gas injection control process monitoring
- Hydraulic units for controlling hydraulic actuators, valve pins and retractable gas and water nozzles

At your side, everywhere

With our international partner companies, experienced experts in high-pressure technology are always ready to assist you. We have compiled detailed contact information for our international partners which you can find on our website at:

www.maximator.de/worldwide+distribution.

MAXIMATOR GmbH

Lange Strasse 6, 99734 Nordhausen Germany,

Telephone +49 (0) 3631 9533-0,

Telefax +49 (0) 3631 9533-5010

info@maximator.de

» Visit our Website:
www.maximator.de